

User's Guide

for the



Ampeg

SVT1000

Bass Amplifier



Made with Pride in the U.S.A. by



Ampeg



TABLE OF CONTENTS

Introduction	3
Features	3
The Front Panel	4
The Rear Panel	5
Some Suggested Settings	6
Troubleshooting	7
System Block Diagram	7
Technical Specificationsback cover

Declaration of Conformity

Manufacturer's Name: SLM Electronics
Corporate Headquarters: 1901 Congressional Drive, St. Louis, Missouri 63146
Primary Production Facility: 700 Hwy 202 W, Yellville, Arkansas, 72687

Product Type: Audio Amplifier

Products meet the regulations for compliance marking under:

- ETL standards UL6500, UL60065, or UL813
- CSA standards E60065 or C22.2 No.1-M90
- CE safety standard EN60065
- CE EMC standards EN55103 or EN55013 and EN61000
- FCC standards 47CFR 15.107 and 15.109 Class A
- C-tick designation Level 2, ABN #56748810738, ARBN# N222
- KETI standard K60065 (limited model approval)

Compliance Support Contact: SLM Electronics, Attn: R&D Compliance Engineer
 1901 Congressional Drive, St Louis, Missouri, 63146 • Tel.: 314-569-0141, Fax: 314-569-0175

	CAUTION RISK OF ELECTRIC SHOCK DO NOT OPEN	
WARNING: TO REDUCE THE RISK OF FIRE OR ELECTRIC SHOCK, DO NOT EXPOSE THIS APPARATUS TO RAIN OR MOISTURE. TO REDUCE THE RISK OF ELECTRIC SHOCK, DO NOT REMOVE COVER. NO USER-SERVICEABLE PARTS INSIDE. REFER SERVICING TO QUALIFIED SERVICE PERSONNEL.		

	PRECAUCION RIESGO DE CORRIENTAZO NO ABRA	
PRECAUCION: PARA REDUCIR EL RIESGO DE INCENDIOS O DESCARGAS ELECTRICAS, NO PERMITA QUE ESTE APARATO QUEDA EXPUESTO A LA LLUVIA O LA HUMEDAD. PARA DISMINUIR EL RIESGO DE CORRIENTAZO, NO ABRA LA CUBIERTA. NO HAY PIEZAS ADENTRO QUE EL USUARIO PUEDE REPARAR DE JE TODO MANTENIMIENTO A LOS TECNICOS CALIFICADOS.		

	ATTENTION RISQUE D'ELECTROCUTION NE PAS OUVRIR	
ATTENTION: PROTEGEZ CET APPAREIL DE LA PLUIE ET DE L'HUMIDITE AFIN D'EVITER TOUT RISQUE D'INCENDIE OU D'ELECTROCUTION. POUR REDUIRE D'ELECTROCUTION NE PAS ENLEVER LE COUVERCLE. AUCUNE PIECE INTERNE N'EST REPARABLE PAR L'UTILISATEUR. POUR TOUTE REPARATION, S'ADRESSEZ A UN TECHNICIEN QUALIFIE.		

IMPORTANT SAFETY INSTRUCTIONS

- READ, FOLLOW, HEED, AND KEEP ALL INSTRUCTIONS AND WARNINGS.
- DO NOT OPERATE NEAR ANY HEAT SOURCE AND DO NOT BLOCK ANY VENTILATION OPENINGS ON THIS APPARATUS. FOR PROPER OPERATION, THIS UNIT REQUIRES 3' (75CM) OF WELL VENTILATED SPACE AROUND HEATSINKS AND OTHER AIR FLOW PROVISIONS IN THE CABINET.
- DO NOT USE THIS APPARATUS NEAR SPLASHING, FALLING, SPRAYING, OR STANDING LIQUIDS.
- CLEAN ONLY WITH LINT-FREE DAMP CLOTH AND DO NOT USE CLEANING AGENTS.
- ONLY CONNECT POWER CORD TO A POLARIZED, SAFETY GROUNDED OUTLET WIRED TO CURRENT ELECTRICAL CODES AND COMPATIBLE WITH VOLTAGE, POWER, AND FREQUENCY REQUIREMENTS STATED ON THE REAR PANEL OF THE APPARATUS.
- PROTECT THE POWER CORD FROM DAMAGE DUE TO BEING WALKED ON, PINCHED, OR STRAINED.
- UNPLUG THE APPARATUS DURING LIGHTNING STORMS OR WHEN UNUSED FOR LONG PERIODS OF TIME.
- ONLY USE ATTACHMENTS, ACCESSORIES, STANDS, OR BRACKETS SPECIFIED BY THE MANUFACTURER FOR SAFE OPERATION AND TO AVOID INJURY.
- WARNING: TO REDUCE THE RISK OF ELECTRIC SHOCK OR FIRE, DO NOT EXPOSE THIS UNIT TO RAIN OR MOISTURE.
- SERVICE MUST BE PERFORMED BY QUALIFIED PERSONNEL.
- OUR AMPLIFIERS ARE CAPABLE OF PRODUCING HIGH SOUND PRESSURE LEVELS. CONTINUED EXPOSURE TO HIGH SOUND PRESSURE LEVELS CAN CAUSE PERMANENT HEARING IMPAIRMENT OR LOSS. USER CAUTION IS ADVISED AND EAR PROTECTION IS RECOMMENDED IF UNIT IS OPERATED AT HIGH VOLUME.



EXPLANATION OF GRAPHICAL SYMBOLS:
 EXPLICACION DE SIMBOLOS GRAFICOS:
 EXPLICATION DES SYMBOLES GRAPHIQUES:

= "DANGEROUS VOLTAGE"
 "VOLTAJE PELIGROSO"
 "DANGER HAUTE TENSION"

= "IT IS NECESSARY FOR THE USER TO REFER TO THE INSTRUCTION MANUAL"
 "ES NECESARIO QUE EL USUARIO SE REFIERA AL MANUAL DE INSTRUCCIONES."
 "REFERREZ-VOUS AU MANUAL D'UTILISATION"



An Introduction to your new Ampeg SVT1000 Bass Amplifier

Thank you for making one of the best choices you will ever make for your musical career – choosing one of the finest bass amps available, the Ampeg SVT1000. This versatile and powerful bass amplifier delivers up to 1350 watts of unsurpassed musical power, and offers several outstanding features.

All of the features and controls of your SVT1000 are covered in detail within the pages of this user's guide. We recommend that you read this guide and understand them before you use the amplifier.

Features

In the world of high performance bass amps, Ampeg amplifiers stand alone. In true Ampeg tradition, the SVT1000 offers you more power, performance and flexibility than any other bass amplifier in its class. The outstanding features of your new amplifier, features which set it apart from the competition, are listed below.

- **5-POSITION STYLE CONTROL:** Take your pick from five different tone variations to best suit your playing style
- **TEXTURE CONTROL:** Ampeg's exclusive "tube emulation" circuit which changes the tone for a more aggressive sound
- **9-BAND GRAPHIC EQ:** Switchable at front panel or with a footswitch, you can use this as a "second channel" for bass solos, or to shape your sound to your own exacting standards - an independent level control lets you adjust the Graphic EQ volume
- **EFFECTS MIX:** Varies the amount of external effects mixed into the signal
- **TUNER OUT JACK:** Allows connection to an electronic tuner and provides an "always live" monitor feed even when the output is muted
- **HEAVY-DUTY SPEAKER JACKS:** Speakon® jacks for more reliable connections at higher output
- **BALANCED AND UNBALANCED LINE OUTPUTS:** Independent level control - balanced XLR and unbalanced 1/4" output jacks - switchable pre or post EQ - ground lift for balanced XLR
- **EFFECTS LOOP:** Connect external effects here for increased intensity and quieter operation
- **POWER AMP IN/PREAMP OUT:** A separate preamp may be connected to the Power Amp In jack, and the Preamp Out jack may be connected to a slave amp
- **FOOTSWITCH CONTROL:** Use a footswitch to activate the Graphic EQ and the Mute feature
- **CIRCUIT BREAKER PROTECTION:** A heavy duty resettable circuit breaker provides protection against fault conditions



The Front Panel

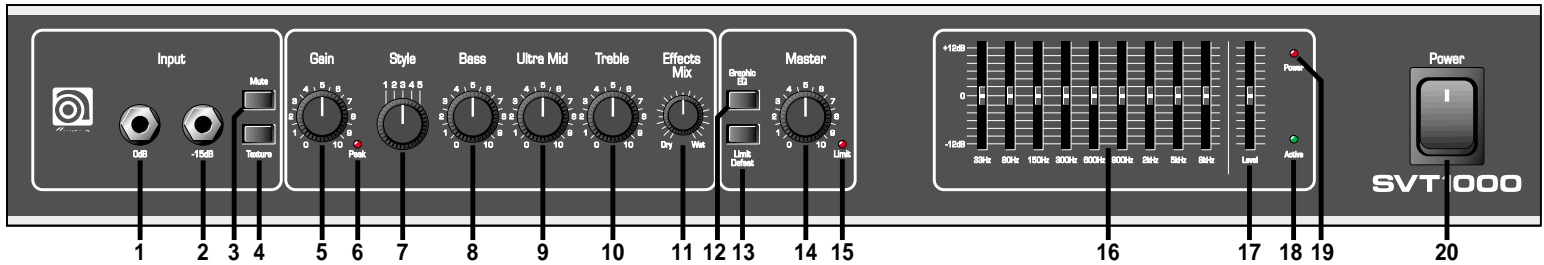

1. 0dB INPUT: The signal output from an instrument (active or passive – typically passive) or a line level signal may be connected here by means of a shielded instrument cable. The signal at this jack is sent into the pre-amp at full amplitude.

2. -15dB INPUT: The signal output from an instrument (active or passive – typically active) or a line level signal may be connected here by means of a shielded instrument cable. The signal at this jack is padded 15dB before it is sent into the preamp.

3. MUTE: This switch, when depressed, mutes all outputs *except* the Tuner Out (#25). A footswitch can also control muting if the Mute switch on the front panel is left in the “out” position. (The front panel switch stays active with a footswitch connected.) This is excellent for tuning your bass with an electronic tuner without having to adjust any levels or turn down your house volume.

4. TEXTURE: This switch adds a “tube emulation” stage which changes the tone for a more aggressive sound. Using the Texture switch, you can overdrive the amplifier without typical (and harsh-sounding) solid state clipping.

5. GAIN: Use this control to adjust the level of the signal entering the pre-amp stage. Adjust this control until the Peak LED (#6) flashes on strong signal peaks (but is not illuminated constantly while playing). To obtain the best signal to noise ratio, set the Gain control as described above and adjust the Master (#14) to obtain the desired volume level.

6. PEAK LED: This LED will illuminate when the signal entering the pre-amp stage is near the clipping level. Adjust the Gain control (#5) until a strong signal from your instrument causes this LED to flash.

7. STYLE: Use this five-position switch to vary the tone of the amplifier. The following table lists each of the different settings – experiment with the Style and other EQ controls for the results which suit you best.

- POSITION 1:** Fully “scooped” mids (mid cut)
- POSITION 2:** Traditional passive tone setting
- POSITION 3:** Basically flat
- POSITION 4:** Boosted high end
- POSITION 5:** Basically flat with low end roll off – for loud playing without “muddiness”

8. BASS: Use this control to adjust the low frequency level of the amplifier. This control provides 12dB of cut or boost at 50Hz. The low frequency output is flat at the center position.

9. ULTRA MID: Use this control to adjust the midrange frequency level of the amplifier. This control provides 7dB of cut (fully counterclockwise) at 400Hz or boost (fully clockwise) at 800Hz. The midrange frequency output is flat at the center position.

10. TREBLE: Use this control to adjust the high frequency level of the amplifier. This control provides 18dB of cut or boost at 5kHz. The high frequency output is flat at the center position.

11. EFFECTS MIX: This control varies the mix between the direct (dry) signal and the effects (wet) when the effects loop (#26,27) is used. Full counterclockwise results in all direct signal (no effect) and full clockwise gives all effect and no direct signal. The fully clockwise position is equivalent to a series effects loop and should be used with such devices as limiters and equalizers.

12. GRAPHIC EQ: This switch, when depressed, activates the graphic equalizer. When a footswitch is used, this switch is disabled.

13. LIMIT DEFEAT: The SVT1000 employs internal limiter circuits to help keep the power amplifier’s output clean at extreme volume levels. (All amplifiers may begin to clip their output signals as they approach maximum output levels, resulting in potentially speaker-damaging distortion.) These circuits may be disabled by depressing this switch. This may result in an increase in output power, but also increases the possibility of distortion. Use discretion whenever playing with the Limit circuits off.

14. MASTER: Use this control to adjust the overall output level of the amplifier. For the lowest possible noise level, adjust the Gain control as described in #5 and use this control to obtain the desired volume level.

15. LIMIT LED: This LED illuminates when the internal limit circuit is called upon to keep the amplifier’s output signal clean. This indicates that the amplifier is nearing full output and the limiter is keeping it from clipping the output signal.

16. 9-BAND GRAPHIC EQ: Use these sliders to control the amplitude of the frequencies indicated above each control. The center position of each control is flat: sliding the control upward will increase the output level of that frequency; sliding the control downward will decrease it.

17. LEVEL: Use this slider to adjust the output level of the Graphic EQ. If the EQ’d signal is too soft, slide the Level control up; if it’s too loud, slide the control down.

18. ACTIVE: This LED illuminates when the EQ is on.

19. POWER: This LED illuminates when the amplifier is on.

20. POWER: Use this switch to turn the amplifier on (top of the switch depressed) and off (bottom of the switch depressed).



The Rear Panel

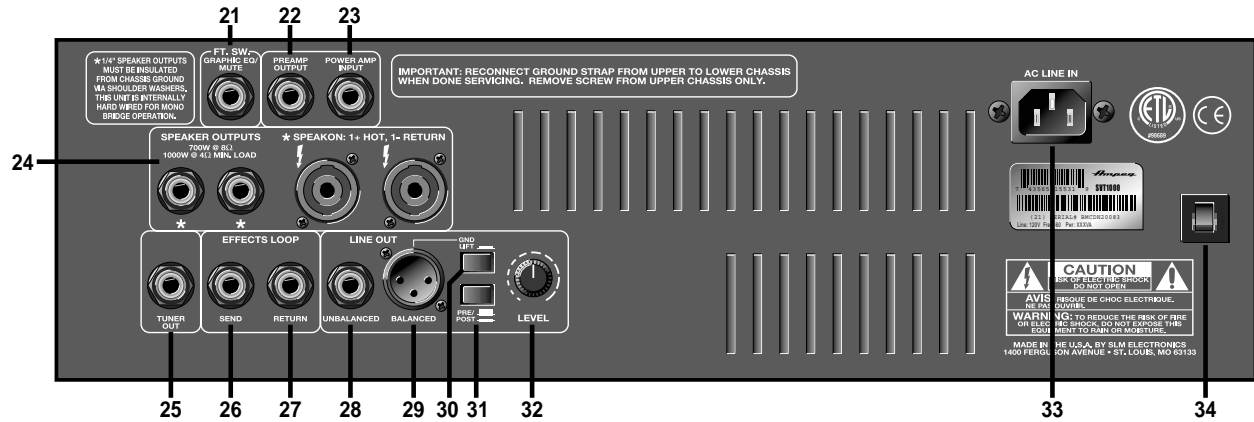

21. FOOTSWITCH: Use this jack to connect a two button footswitch for remote Mute and EQ On/Off control. (Tip = Mute, ring = EQ On/Off.) When a footswitch is connected, the Mute switch (#3) remains active; however, the Graphic EQ switch (#12) is disabled.

22. PREAMP OUTPUT: This jack is a direct preamp output for use with external power amplifiers, mixing boards, external effects, etc. Connect the external unit's input to this jack by means of a shielded signal cable.

23. POWER AMP INPUT: This jack connects directly to the power amp for use with an external preamp. When using an external source, connect its output to this jack by means of a shielded signal cable to feed the signal into the power amp section. The amplifier's input signal is disconnected when a plug is inserted into this jack.

24. SPEAKER OUTPUTS: The 1/4" jacks offer a convenient method of connecting to speaker cabinets using cables terminated with 1/4" plugs. However, when using the amplifier at or near its full output power, using the Speakon® jacks is recommended. (Pin 1+ = hot, pin 1- = return.)

NOTE: This amp is internally hard wired for bridge mode operation. Do not remove the insulating washers from the 1/4" Speaker Output jacks. Removing the insulating washers will damage the amplifier and void your warranty.

25. TUNER OUT: Use this jack to connect the amplifier to an electronic tuner. The signal at this jack is always "live," even when the Mute switch (#3) is engaged, allowing for "silent tuning" as well as a monitor feed which remains active when the house mix is muted.

26. EFFECTS LOOP SEND: Use this jack to sent a signal to the input of an external effect by means of a shielded signal cable.

27. EFFECTS LOOP RETURN: Use this jack to connect the output signal from an external effect to the amplifier by means of a shielded signal cable.

28. LINE OUT UNBALANCED: Use this 1/4" jack to send an unbalanced line level signal to a house mixing board, recording console, or external amplifier. The signal level at this jack is controlled by the Line Out Level control (#32) and may be Pre or Post-EQ depending on the setting of the Line Out Pre/Post switch (#31).

29. LINE OUT BALANCED: Use this XLR jack to send a balanced line level signal to a house mixing board, recording console, or external amplifier. The signal level at this jack is controlled by the Line Out Level control (#32) and may be Pre or Post-EQ depending on the setting of the Line Out Pre/Post switch (#31).

30. LINE OUT GROUND LIFT: This switch, when depressed, disconnects the ground connection at the Balanced Line Out jack (#29). This may help reduce residual hum and buzz sometimes picked up in line out signal cables.

31. LINE OUT PRE/POST: This switch, when depressed, sends a Post-EQ signal to the Line Out jacks (#28,29). The Post-EQ signal is modified by the settings of the tone controls, Graphic Eq and effects loop. With the switch in the out position, the signal sent to the Line Out jacks is Pre-EQ. The Pre-EQ signal is a direct output and is not affected by any of the pre-amp settings.

32. LINE OUT LEVEL: Use this control to adjust the signal level at the Line Out jacks (#28,29). This control works independently from the Master control (#14).

33. AC LINE IN: Firmly insert the supplied AC power cord into this socket until it is fully seated. This grounded power cord is to be plugged into a grounded power outlet, wired to current electric codes and compatible with voltage, power, and frequency requirements stated on the rear panel. **Do no attempt to defeat the safety ground connection.**

34. CIRCUIT BREAKER: The SVT1000 employs an AC line circuit breaker to help protect against damage due to excessive current demands. If the amplifier stops working, check the circuit breaker. If it has opened, the button will be protruding and showing a contrasting color. You can reset the circuit breaker by pushing it in until it latches. The breaker must cool down for a short time before the button will latch. If the circuit breaker opens repeatedly, have the amplifier checked by a qualified service person.

IMPORTANT NOTE: This unit employs forced air cooling by means of an internal fan system. The front and rear ventilation slots must remain unobstructed when operating this amplifier.



Some Suggested Settings

Since so many variables affect the actual sound of any system, the following settings are offered as starting points to help you find the exact sounds your playing demands. When using the SVT1000, please keep in mind the following points:

- The Gain control should be adjusted until the peak LED flashes on strong signals. (This level will vary, depending on your instrument and playing style.)
- The Master control should be set to produce the appropriate output volume level.
- The Graphic EQ can be used to further fine-tune these basic suggested setting, to extend the frequency response of the cabinet being used, to compensate for room acoustics, or to act like a “second channel.”

ROCK:

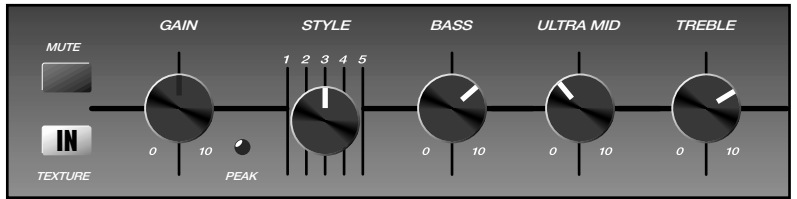

JAZZ:

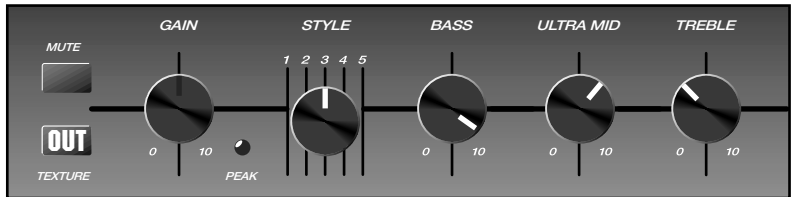

COUNTRY:

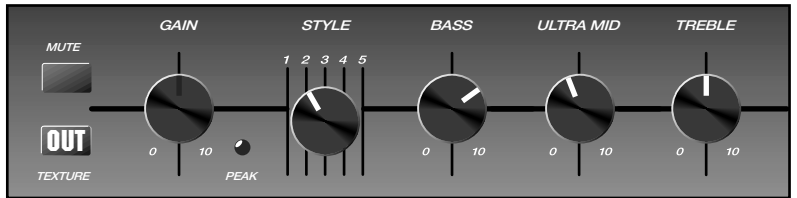

BRIGHT:

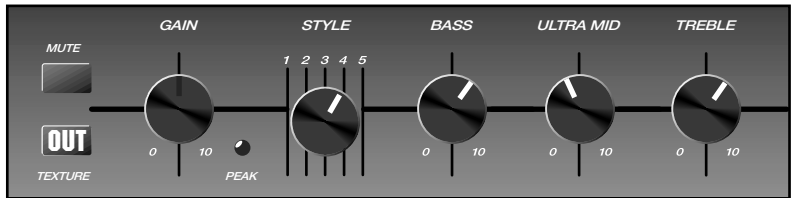

FUNK “POPPING:”

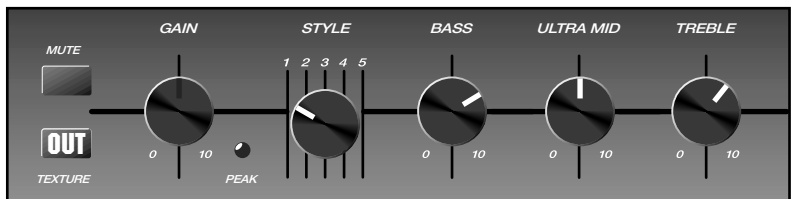



Troubleshooting

In the unlikely event that your SVT1000 should malfunction, take a few minutes to troubleshoot it before you call for service. You can save yourself time and money by doing it yourself, and often the problem is something quite simple.

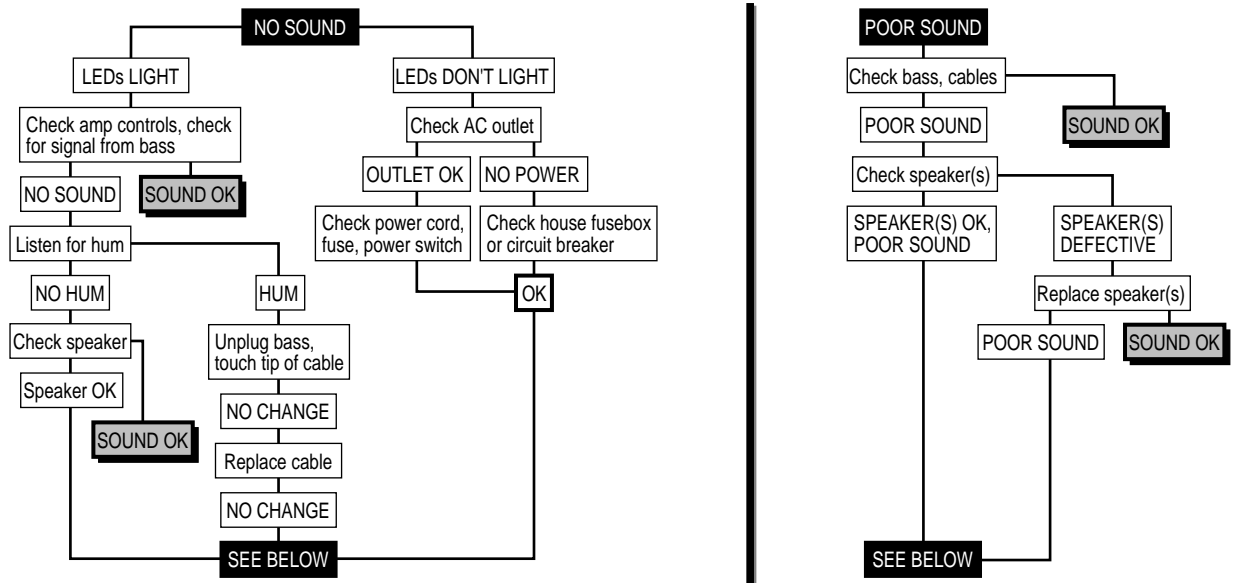

If the problem isn't covered above, or if the steps lead you here, then contact your Ampeg dealer for service information. Also, you should refer your amp to an authorized service center if it gets dropped, has liquid spilled into it, or sustains damage to its power cord. Regular cleaning and maintenance by your local Service Center will help extend the useful life of the amplifier.

System Block Diagram

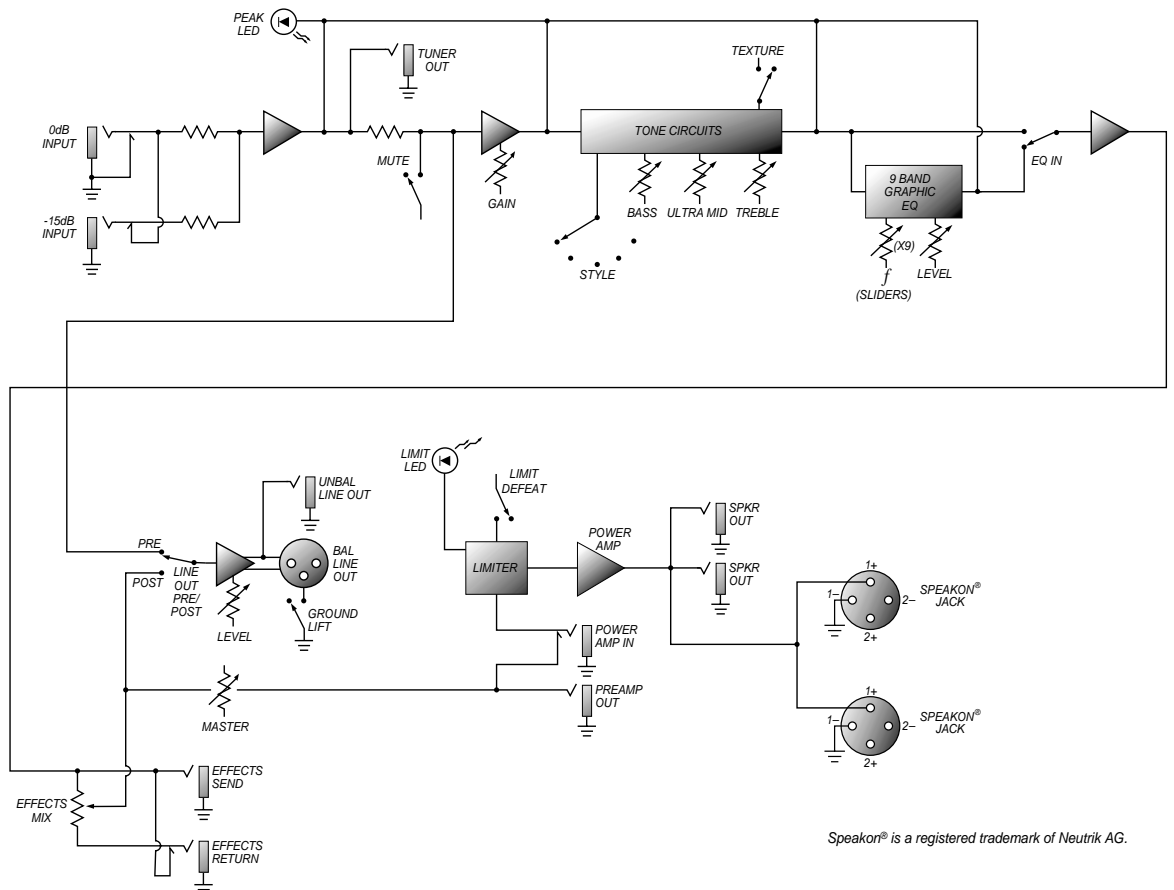

Speakon® is a registered trademark of Neutrik AG.



Technical Specifications

OUTPUT POWER RATING	1350 Watts @ 4 Ohms (1000 Watts Continuous) 840 Watts @ 8 Ohms (680 Watts Continuous)
TONE CONTROL RANGE	Bass: ±12dB @ 50Hz Ultra Mid: +7dB @ 800Hz, -7dB @ 400Hz Treble: ±18dB @ 5kHz
GRAPHIC EQ LEVEL	±6dB
GRAPHIC EQ RANGE	33Hz: ±15dB 80Hz: ±10dB 150Hz: ±8dB 300Hz: ±8dB 600Hz: ±8dB 900Hz: ±8dB 2kHz: ±8dB 5kHz: ±10dB 8kHz: ±12dB
SIGNAL TO NOISE RATIO	75dB typical
FOOTSWITCH JACK	Graphic EQ On/Off, Mute On/Off – Tip = Mute, Ring = EQ
POWER REQUIREMENTS	Domestic: 120VAC, 60Hz, 800VA Export: 100VAC 50/60Hz, 800VA 230VAC, 50Hz, 800VA 240VAC, 50Hz, 800VA
SIZE AND WEIGHT	24" W x 11-3/4" H x 14" D; 57 lbs

Ampeg reserves the right to change specifications without notice.



www.ameg.com

