

# *Ampeg*®

## SVT-VR

### Bass Guitar Amplifier



Owner's Manual

## TABLE OF CONTENTS

What's in the Box .....	2
Introduction .....	2
Features .....	3
The Front Panel .....	4
The Rear Panel .....	6
Suggested Settings .....	8
Personal Settings .....	8
Important Information About Tubes.....	10
Survival Tips for Tube Amplifiers .....	12
Changing the Tubes .....	13
Setting Tube Bias and Balance .....	14
Troubleshooting .....	14
Block Diagram .....	15
Technical Specifications.....	16
Warranty and Support .....	17

## What's in the Box

SVT<sup>+</sup>-VR Amplifier, Power Cable, Quick Start Guide.

## Introduction

***Congratulations!*** You are now the proud owner of an Ampeg SVT-VR bass guitar amplifier. This versatile and powerful bass amplifier delivers up to 300 watts of unsurpassed quality, offering the classic vibrance of tubes, as well as contemporary features.

The SVT-VR amplifier is an ideal companion to the SVT-410HLF, SVT-610HLF, SVT-810AV, or SVT-810E speaker cabinets, available separately.

Like all Ampeg products, your SVT-VR amplifier is designed by musicians and built using only the best of components. Each amplifier is tested to confirm that it meets our specifications, and we believe that this amplifier is the absolute best that it can be. In order to get the most out of your new amplifier, please read this manual, as well as the *Important Safety Instructions* included with your SVT-VR amplifier, before you begin playing.

And **thank you** for choosing Ampeg.

## Features

- **TWO-CHANNEL OPERATION:** Two separate channels with independent tone and volume controls
- **NORMAL AND BRIGHT INPUTS:** Each channel offers a choice of inputs: Normal or Bright (high-end enhanced)
- **ULTRA HI, ULTRA LO AND BASS CUT (CH. 1 ONLY) SWITCHES:** Lets you tailor your sound in many different ways with the touch of a button.
- **MIDRANGE FREQUENCY SELECT "1-2-3" SWITCH (CH. 1 ONLY):** Allows you to select the operating range for the Midrange control for increased tonal flexibility.
- **BIAS ADJUSTMENT CONTROLS:** Lets you adjust the tube bias and balance for optimal operation.
- **SLAVE OUT:** Use for powering another amp from the SVT-VR preamp.
- **POWER AMP IN / PREAMP OUT:** A separate preamp may be connected to the Power Amp In jack, and the Preamp Out jack may be connected to a slave amp.
- **TRANSFORMER BALANCED LINE OUT:** Independent Level control, balanced XLR Output jack, switchable Pre or Post EQ, and Ground Lift for Balanced XLR.
- **HEAVY-DUTY SPEAKER JACKS:** Speakon® jacks for more reliable connections at higher output.

## The Front Panel

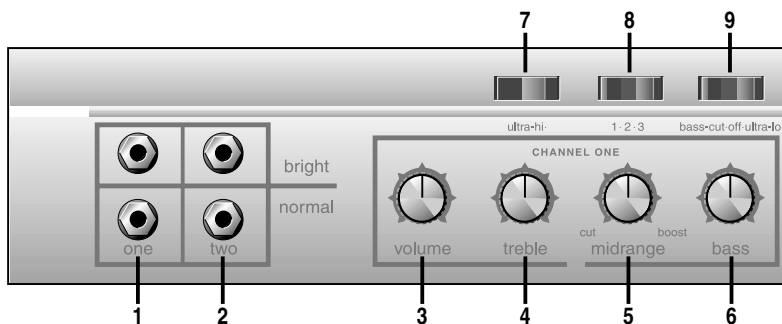

- 1. ONE (Channel One Input jacks):**  
The signal output from an instrument or a line level signal may be connected to this 1/4" Input by means of a shielded instrument cable. Either the Bright or Normal jack may be used. The Bright jack enhances the high frequencies of the input signal. The signal at these jacks is sent into the Channel One preamp section.
- 2. TWO (Channel Two Input jacks):**  
The signal output from an instrument or a line level signal may be connected to this 1/4" Input by means of a shielded instrument cable. Either the Bright or Normal jack may be used. The Bright jack enhances the high frequencies of the input signal. The signal at these jacks is sent into the Channel Two preamp section.
- 3. VOLUME:** Use this control to adjust the output level of Channel One.
- 4. TREBLE:** Use this to adjust the high frequency level of Channel One. This provides up to 12 dB of boost, or 12 dB of cut, at 4 kHz. The high frequency output is flat at the center position.
- 5. MIDRANGE:** Use this to adjust the midrange frequency level of Channel One. This provides up to 20 dB of boost, or 20 dB of cut at the selected frequency [8]. The midrange frequency output is flat at the center position.
- 6. BASS:** Use this to adjust the low frequency level of Channel One. This provides up to 12 dB of boost, or 12 dB of cut, at 40 Hz. The low frequency output is flat at the center position.
- 7. ULTRA-HI:** This switch, when engaged (right side down), enhances the amount of high frequency output of Channel One. The amount of boost is dependent on the setting of the volume control [3].
- 8. 1-2-3:** This switch selects the frequency that will be affected by the Midrange control [5]. The available frequencies are 220 Hz (left side of the switch engaged), 800 Hz (switch in the center position), or 3 kHz (right side of the switch engaged).
- 9. BASS-CUT/OFF/ULTRA-LO:** Engaging the left side of this switch decreases the low frequency output of Channel One. Engaging the right side of this switch enhances the low frequency output of Channel One. The switch is inactive in the center position.

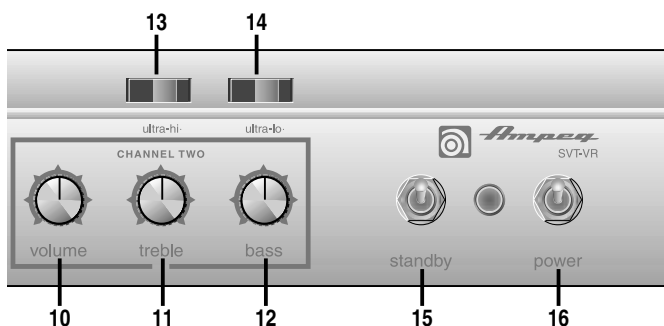

10. **VOLUME:** Use this control to adjust the output level of Channel Two.
11. **TREBLE:** Use this to adjust the high frequency level of Channel Two. This provides up to 12 dB of boost, or 12 dB of cut, at 4 kHz. The high frequency output is flat at the center position.
12. **BASS:** Use this to adjust the low frequency level of Channel Two. This provides up to 12 dB of boost, or 12 dB of cut, at 40 Hz. The low frequency output is flat at the center position.
13. **ULTRA-HI:** This switch, when engaged (right side down), enhances the amount of high frequency output of Channel Two. The amount of boost is dependent on the setting of the Volume control [10].
14. **ULTRA LO:** This switch, when engaged (right side down), enhances the low frequency output of Channel Two.
15. **STANDBY SWITCH:** Flick the switch up to turn the Standby mode on. The Standby mode allows the tubes to warm up, or remain warm, without high voltage being applied to them, helping to extend tube life. This switch should be OFF when initially turning the amplifier on. Allow the unit to warm up for at least 20 seconds before switch-ing Standby to the ON position. During short periods of non-use, the amp should be put into Standby mode.
16. **POWER SWITCH:** Flick the switch up to turn on the power. The Power switch should be engaged prior to the Standby switch (as mentioned above, #15). This switch must be turned off to reset the amp after a fault condition. The adjacent lamp illuminates green when the amplifier is on and is *not* in Standby mode.

## The Rear Panel



**17. IEC POWER INPUT CONNECTOR:** This is where you connect the supplied AC power cord. Plug the male end of the cord into a grounded AC outlet.

 **DO NOT DEFEAT THE GROUND PRONG OF THE AC PLUG**

**18. FUSE:** This protects the unit from damage due to overload conditions or power line surges. If the fuse blows, replace it only with the same size and type.

**19. POLARITY:** Place this switch in the position that provides the least electrical buzz from the unit.

**20. BIAS / BALANCE SECTION:** These controls and sets of LEDs allow the user to properly bias the power amp. See "[Setting Tube Bias and Balance](#)" on [page 14](#) for a complete description of how to use this section.

**21. SLAVE OUT:** The Slave Out is for slaving two amps together: it connects both their power amps and their preamps.

**22. POWER AMP IN:** This jack connects directly to the internal power amp for use with an external preamp. When using an external source, connect the OUTPUT of the source to this jack using a shielded instrument cable to feed the signal into the power amp section. The internal signal is disconnected when a plug is inserted into this jack.

**23. PREAMP OUT:** This jack is a direct post Master preamp output for use with an external power amp. Connect the external amp's input to this jack using a shielded instrument cable.

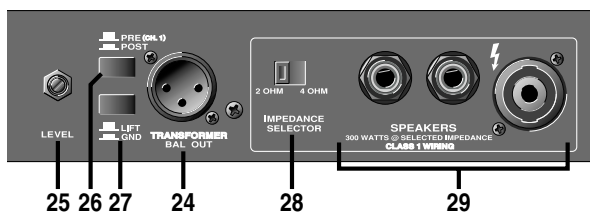

**24. TRANSFORMER BALANCED OUT:** This signal may be used to feed an external power amplifier, mixing console or house PA system.

The signal level at this jack is controlled by the Level control [25] and may be Pre or Post EQ depending on the setting of the Pre/Post switch [26]. Additionally, the Lift/Ground switch [27] is available to reduce any noise that may occur at the Transformer Balanced Output.

**25. LEVEL:** Use this control to adjust the signal level at the transformer Balanced Output jack [24]. This control works independently from the front panel Volume controls [3, 10].

**26. PRE (CH. 1) / POST:** The signal at the Transformer Balanced Output jack [24] can be set to either Pre EQ or Post EQ with this switch. With the switch in the OUT position, the signal at the jacks is Pre EQ. This is a direct output, not affected by any volume or tone controls. With the switch in the IN position, the signal is Post EQ and is controlled and modified by the Volume and tone controls.

**27. LIFT / GND:** When this switch is engaged, it connects the ground connection at the Transformer Bal Out jack [24]. This may help reduce residual hum and buzz sometimes picked up in line out signal cables.

**28. IMPEDANCE SELECTOR:** Use this switch to match the output impedance of the amp to the speaker(s) being used (2 Ω or 4 Ω). For help in deciding the total impedance of your system, consult the following table.

Cabinet Impedance	Number of Cabinets	Total Impedance
2 Ω	1	2 Ω
4 Ω	1	4 Ω
4 Ω	2	2 Ω
8 Ω	2	4 Ω
8 Ω	4	2 Ω

**29. SPEAKER OUTPUTS:** Two 1/4" output jacks and one Speakon output jack supply speaker-level power to the cabinet. The rated power output is 300 Watts RMS into 2 or 4 Ω.

The two identical outputs are wired in parallel, and you can use either one, or use both. Make sure the total speaker impedance load is 2 Ω or greater.

Use speaker cables with Speakon or 1/4" TS ends to make the connections. Do not use instrument cables as they may overheat.

**NOTE:** In some areas, 1/4" speaker jacks are not appropriate for use on amplifiers with high output power levels. For this reason, use the Speakon jack instead.

## Suggested Settings

**Standard**

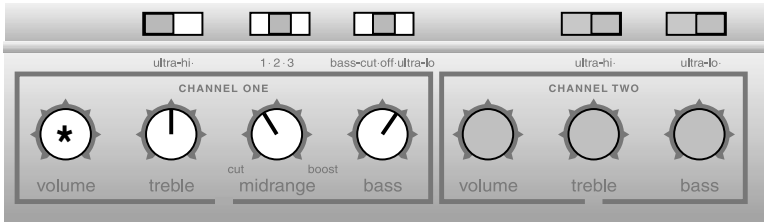

**Back Pickup  
Fretless**

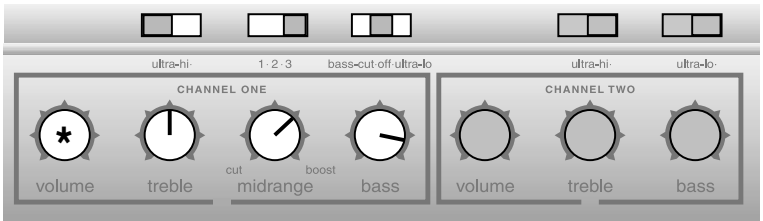

**Hard Edge**



**"Scooped"**



\* = as needed



## Personal Settings

ultra-hi:    1 · 2 · 3    bass-cut-off-ultra-lo    ultra-hi:    ultra-lo:

**CHANNEL ONE**

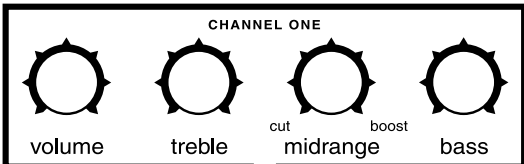

volume    treble    cut    boost    midrange    bass

**CHANNEL TWO**

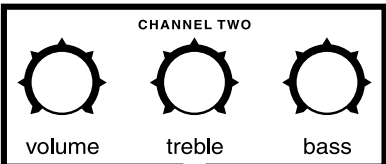

volume    treble    bass

ultra-hi:    1 · 2 · 3    bass-cut-off-ultra-lo    ultra-hi:    ultra-lo:

**CHANNEL ONE**

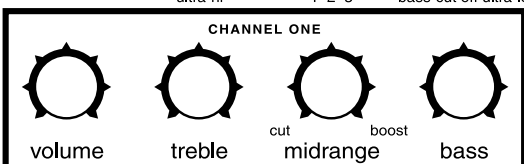

volume    treble    cut    boost    midrange    bass

**CHANNEL TWO**

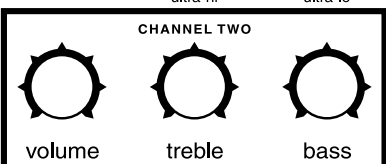

volume    treble    bass

ultra-hi:    1 · 2 · 3    bass-cut-off-ultra-lo    ultra-hi:    ultra-lo:

**CHANNEL ONE**

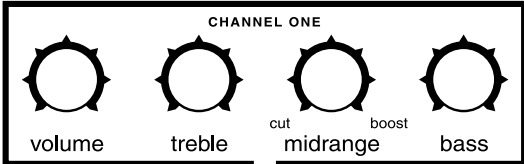

volume    treble    cut    boost    midrange    bass

**CHANNEL TWO**

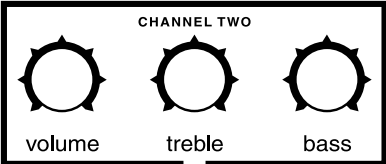

volume    treble    bass

ultra-hi:    1 · 2 · 3    bass-cut-off-ultra-lo    ultra-hi:    ultra-lo:

**CHANNEL ONE**

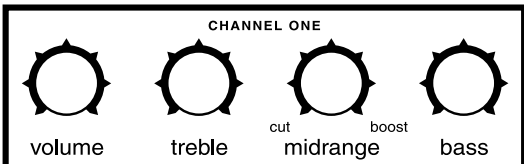

volume    treble    cut    boost    midrange    bass

**CHANNEL TWO**

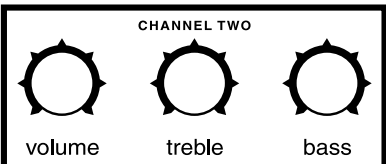

volume    treble    bass

## Important Information About Tubes

### ***A Brief History of the Tube***

In 1883, Thomas Edison discovered that electrons would flow from a suspended filament when enclosed in an evacuated lamp. Years later, in 1905, John Ambrose Fleming expanded on Edison's discovery and created the "Fleming Valve." Then, in 1907, Dr. Lee de Forest added a third component – the grid – to "Fleming's Valve" and the vacuum tube was a fact of life. The door to electronic amplification was now open.

During World War II, data gleaned from their intensive research on the detectors used in radar systems led Bell Telephone Laboratories to the invention of the transistor. This reliable little device gained quick support as the new component for amplification. The death of the vacuum tube seemed imminent as designers, scientists, and engineers reveled in the idea of replacing large, fragile glass tubes with these small, solid-state devices.

However, there were (and still are) many serious listeners who realized that the sound produced by a "transistor" amplifier is significantly different from that produced by a tube amplifier with identical design specifications. They considered the sound produced by these new solid-state devices to be hard, brittle, and lifeless. It was determined that solid-state devices produced a less musical set of harmonics than tubes. When pushed past their limits, they tend to mute the tone and emphasize the distortion.

Tubes, on the other hand, produce a more musical set of harmonics, the intensity of which may be controlled by the player. This characteristic adds warmth and definition to the sound, which has become the hallmark of tube amplifiers. When tubes are driven into clipping, the harmonic overtones can be both sweet and pleasing, or intense and penetrating, depending on the musician's taste and playing technique.

Over the years, application engineers have designed a number of outstanding solid-state amplifiers that sound very, very good. Some use special circuitry which enables them to simulate distortion characteristics of a tube amplifier. However, the tube amplifier, still held in the highest esteem by many musicians, offers a classic "vintage" sound in a contemporary market.

### ***Tube Types and Usage***

Tube amplifiers are based primarily on two types of tubes – preamplifier tubes and power tubes. The tubes used in preamplifiers (12AX7, 12AU7, 12AT7, etc.) are smaller than the power tubes. These tubes amplify the signal from the instrument and shape the sound. They are inherently microphonic (mechanically pick up and transmit external noises). Since these tubes are used in the critical first stages of a tube amplifier's circuitry, it is very important that any replacements are high-quality, low noise/low microphonic tubes for this application. Although tubes of this quality may be difficult to find and typically cost more than "off-the-shelf" tubes, the improvement in performance is worth the investment.

Preamplifier tubes are also used to drive the power tubes. When used in this application, a 12AX7 will produce a more distorted tone than a 12AT7 which produces a clearer, sweeter sound. A 12AU7 is even cleaner and brighter than a 12AT7, giving more definition to the sound. It is possible to change the sound of the amplifier by changing the type of preamp and/or driver tubes. When making any modification to your equipment, it is highly recommended that you consult with a qualified service center.

**Power tubes** are the largest tubes used in an amplifier, generate the most heat, and wear out the fastest. These tubes convert the low-level, conditioned signal from the preamplifier into a level that is sufficient to drive the speakers. There are several types of power tubes available, each of which offers a different performance/sound characteristic. For example, the EL34 power tube produces a great classic rock sound. When an EL34 is driven into distortion, it produces a unique “crunch” sound. When compared to the 6L6, the EL34 distorts more quickly, exhibits a “looser” low-end response, and produces more harmonics at mid and high frequencies (a “creamier” sound). These differences become more noticeable at higher volumes.

The 6L6 tubes produce a big low-end thump and have very good dynamic range. They offer a more traditional “American Rock” sound. The 6V6 tubes produce a creamy sound with nice distortion. On the other hand, the KT88 produces a big low-end but sounds more like an EL34 in the mid and high frequencies.

The 6550 power tubes are more rugged and stay cleaner sounding, even at full power. When they do distort, the sound produced is more solid and has a tighter low end; more of a “heavy metal” type distortion with lots of power.

Most power tubes are available in matched sets. These tubes have been extensively tested for optimum performance and longevity. When replacing power tubes, please replace them with a tested, matched set, and have the amp re-biased by a qualified service center. It is possible to change the sound of the amplifier by changing the type of power tubes. When making any modification to your equipment, it is highly recommended that you consult with a qualified service center.

### ***The Nature of Tubes – Why (and When) to Replace Them***

Tubes are made up of a number of fragile mechanical components that are vacuum-sealed in a glass envelope or bubble. The tube’s longevity is based on a number of factors which include how hard and often the amplifier is played, vibration from the speakers, road travel, repeated setup and tear down, etc. Any time you notice a change in the amplifier’s performance, check the tubes first.

If it’s been awhile since the tubes were replaced and the sound from the amplifier lacks punch, fades in and out, loses highs or lows, or produces unusual sounds, the power tubes probably need to be replaced. If the amplifier squeals, makes noise, loses gain, starts to hum, lacks “sensitivity,” or feels as if it is working against you, the preamplifier tubes may need to be replaced.

The power tubes are subjected to considerably more stress than the preamplifier tubes. Consequently, they almost always fail/degrade first. If deteriorating power tubes aren’t replaced, they will ultimately fail. Depending on the failure mode, they may even cause severe damage to the audio output transformer and/or other components in the amplifier. Replacing the tubes before they fail completely has the potential to save time, money and other unwanted troubles. Since power tubes work together in an amplifier, it is crucial that they (if there is more than one) be replaced by a matched set. If you are on the road a lot, we recommend that you carry a spare matched set of replacement power tubes and their associated driver tubes.

After turning off the power and disconnecting the amplifier from the power source, carefully check the tubes (in bright light) for cracks, white spots inside the glass, or any apparent damage. Then, with the power on, view the tubes in a darkened room. Look for the preamplifier tubes that do not glow at all or power tubes that glow excessively red.

**Whenever replacing power tubes:**

- Always have the amplifier's bias voltage checked by a qualified service center. Improper bias voltage will cause degradation in performance and possibly damage tubes and/or the amplifier. See the following *The importance of proper biasing* section for more information on this subject.
- We highly recommend replacing the driver tube(s) as well. The driver tube determines the shape and amplitude of the signal applied to the power tube(s) and has to work almost as hard as the power tube(s).

You may check the preamplifier tubes for microphonics by turning the amplifier on, turning up the gain and tapping lightly on each tube with the end of a pencil or a chopstick. You will be able to hear the tapping through the speakers, which is normal. It is not normal for a tube to ring like a bell after it is tapped. If it does ring, then it is microphonic and should be replaced. Remember to use only high quality, low microphonic tubes in the preamplifier section.

Even though power tubes are rarely microphonic, they should be checked as well. The power tubes may be checked for microphonics in the same manner as described above for the preamp tubes.

In the case of very high gain amps, you may be able to reduce the amount of noise generated by simply swapping the preamp tubes around.

***The Importance of Proper Biasing***

For the best performance and longest tube life, proper biasing is imperative. Bias is the negative voltage which is applied to the power tube's control grid to set the level of idle current. We cannot over-emphasize the difference in warmth of tone and dynamic response that come with proper biasing. If the bias is set too high (over-biased), the sound from the amp will be distorted at all levels. If the bias is set too low (under-biased), the power tubes will run hot (the plates inside the tubes may glow red due to excessive heat) and the sound from the amplifier will lack power and punch. The excessive heat greatly reduces tube life – from a few days to as little as a few hours in extreme cases. Setting the bias on the amp is like setting the idle on a car. If it's too high or hot, it's running away from you, and if it's too low or cold it will choke when you step on it.

The bias is adjusted at the factory in accordance with the type of power tube(s) installed in your amplifier. It is important to point out that tubes of the same type and specification typically exhibit different performance characteristics. Consequently, whenever power tubes are replaced, the bias voltage must be checked and re-adjusted to accommodate the operating parameters of the replacement tubes. The bias adjustment should be performed only by qualified service personnel with the proper, calibrated test equipment.

**Survival Tips for Tube Amplifiers**

To prolong tube life, observe these tips and recommendations:

- Match the impedance of the speaker cabinet(s) to the amplifier. Improper impedance matching will contribute to early tube degradation and may cause premature tube failure.
- Make sure the speaker(s) are properly connected prior to turning on the amplifier.
- After playing the amplifier, allow sufficient time for it to properly cool down prior to moving it. A properly cooled amplifier prolongs tube life due to the internal components being less susceptible to the damage caused by vibration.

- Allow the amplifier to warm up to room temperature before turning it on. The heat generated by the tube elements can crack a cold glass housing.
- Replace the output tube(s) before the performance degrades or the tubes fail completely. Replace the tube(s) on a regular basis; at least once per year or as often as every 4 to 6 months if you play long and hard every day.
- Always have the bias checked after replacing the output tubes (unless the amplifier is equipped with “self-biasing circuitry”). This should be done **ONLY** at a qualified service center.
- Improper biasing could result in the tubes running too hot, which greatly reduces the life of the tubes – or too cold, which results in distorted sound regardless of level settings. Do not play the amplifier if it exhibits these symptoms. Get the bias checked/adjusted immediately to prevent tube failure and/or other damage.
- If the locating notch on the base of the power tube breaks off, replace the tube. This significantly reduces the risk of damaging the amplifier by incorrectly inserting the tube. Protect the amplifier from dust and moisture. If liquid gets into the amplifier proper, or if the amplifier is dropped or otherwise mechanically abused, have it checked out at an authorized service center before using it.
- Proper maintenance and cleaning, in combination with routine checkups by an authorized service center, will ensure the best performance and longest life from the amplifier.



**CAUTION:** Tube replacements should be performed only by qualified service personnel who are familiar with the dangers of hazardous voltages that are typically present in tube circuitry.

## Changing the Tubes

Tubes wear out in direct proportion to how often and how hard you use the amplifier. Power tubes should be checked at least once a year – more frequently if you use the amplifier nearly every day. When power tubes wear out, the amplifier will begin to grow weak, lack punch, fade up and down, or lose highs and lows. Power tubes work together in a push/pull configuration and should be replaced at the same time with matched or balanced tubes. Your dealer can recommend the best replacement tubes for your amplifier.

Preamp tubes aren't worked as hard as power tubes and typically last longer. When a preamp tube wears out, the amplifier may squeal, get noisy, lose gain and sensitivity, or just quit working. A service center can determine which tube(s) may need replacing.

To get to the power tubes in the SVT-VR, the rear screen must be removed and the tube retainer(s) must be moved out of the way. Qualified service persons may follow these steps to change the tubes:

- Turn the amp off, unplug it and let it cool for at least 5 minutes.
- Remove the screws which hold the perforated metal screen to the rear of the cabinet.
- Set the perforated metal screen aside.
- Remove the tube retainer(s) by lifting them off the tube(s) and moving them to one side.
- Grasp the tube at its top and gently work it out of its socket by rocking it slightly back and forth as you lift up on it.

- When inserting new output tubes, align the tab in the tube's plastic base with the slot in the socket and press the tube gently but firmly into place by pushing down on its top.
- Replace the perforated metal screen and screws.
- Power up the amplifier and let it sit for at least 20 minutes. Bias the amplifier as directed in the section below.

## Setting Tube Bias and Balance

### Tube Bias

Allow the amplifier to warm up to proper AC line voltage for at least 20 minutes. With no signal present, adjust each bias control until its adjacent LED illuminates.

The Bias 1 control affects the three power tubes on the left (as viewed from the rear). The Bias 2 control affects the three power tubes on the right (as viewed from the rear).

### Balance

Insert a 40 Hz signal into the amplifier. Adjust the volume control for approximately 25V RMS output. Slowly adjust the Balance control until its adjacent LED illuminates.

## Troubleshooting

In the unlikely event that your SVT-VR should malfunction, take a few minutes to troubleshoot it before you call for service. You can save yourself time and money by doing it yourself, and often the cure for the problem is something quite simple. If you think the problem may be worn out tubes, see [page 11](#) for symptoms of tube failure.

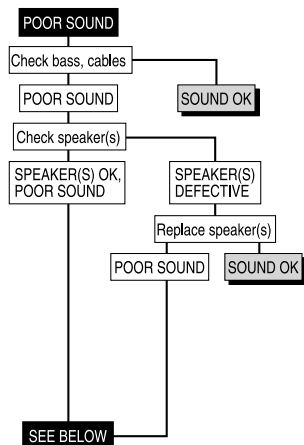
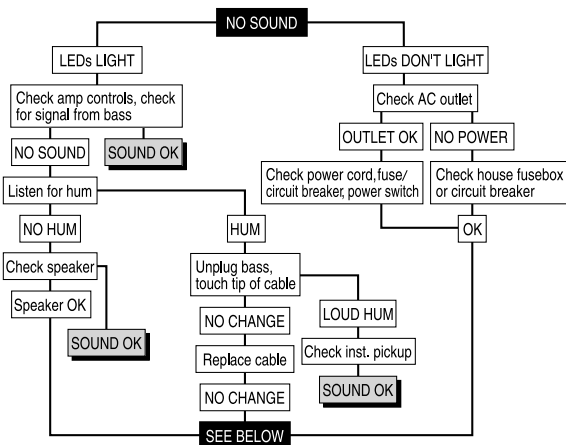

If the problem isn't covered above, or if the steps lead you here, then contact your Ampeg dealer for service information. Also, you should refer the amp for servicing if it gets dropped, has liquid spilled into it, or sustains damage to its power cord.

## Block Diagram

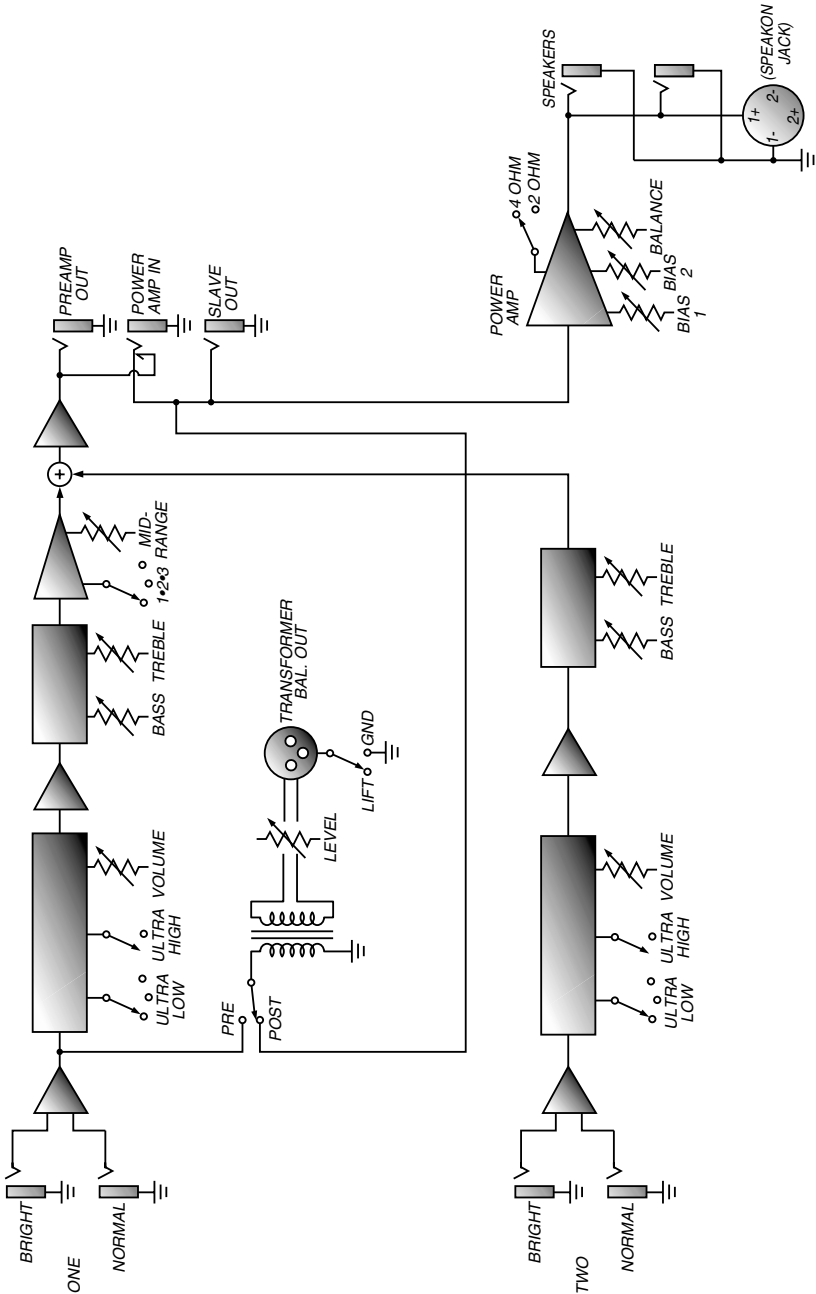

## Technical Specifications

<b>Output Power Rating</b>	
	300 Watts RMS minimum continuous @ <5% THD into 2 or 4 $\Omega$ , 0.25V RMS input
<b>Total System Gain</b>	
<b>Channel One</b>	66 dB @ 1 kHz with volume up and tones flat
<b>Channel Two</b>	59 dB @ 1 kHz with volume up and tones flat
<b>Signal to Noise Ratio</b>	
<b>Channel One</b>	75 dB typical
<b>Channel Two</b>	75 dB typical
<b>Maximum Gain (5% THD)</b>	
	78 dB @ 1 kHz, levels up, tone controls centered; -3 dB @ 20 Hz, 15 kHz
<b>Tube Complement</b>	
	12AX7 (4), 12AU7 (4), 6550 (6)
<b>Tone Controls</b>	
<b>Channel One</b>	<b>Bass:</b> +12 / -12 dB @ 40 Hz <b>Midrange:</b> +20 / -20 dB @ 220 Hz, 800 Hz, or 3 kHz <b>Treble:</b> +12 / -12 dB @ 4 kHz <b>Ultra Hi:</b> +15 dB @ 8 kHz (volume @ 50%) <b>Ultra Lo:</b> -20 dB @ 600 Hz <b>Bass Cut:</b> -20 dB @ 40 Hz
<b>Channel Two</b>	<b>Bass:</b> +12 / -12 dB @ 40 Hz <b>Treble:</b> +12 / -12 dB @ 4 kHz <b>Ultra Hi:</b> +15 dB @ 8 kHz (volume @ 50%) <b>Ultra Lo:</b> +11 dB @ 40 Hz (relative)
<b>Power Requirements</b>	
<b>Domestic</b>	~100 – 120V AC, 50–60 Hz, 400 Watts
<b>Export</b>	~200 – 240V AC, 50–60 Hz, 400 Watts

The SVT-VR is covered with a durable fabric-backed vinyl material. Clean with a dry lint-free cloth. Never spray cleaning agents on the SVT-VR. Avoid abrasive cleansers which would damage the finish.

Ampeg continually develops new products and improves upon existing ones. For this reason, the specifications and information in this manual are subject to change without notice.



## Warranty and Support

Visit [WWW.AMPEG.COM](http://WWW.AMPEG.COM) to...

- (1) ...identify **WARRANTY** coverage provided in your local market. Please keep your sales receipt in a safe place.
- (2) ...**REGISTER** your product.
- (3) ...**CONTACT** Technical Support, or call 818-575-3600.

[www.ameg.com](http://www.ameg.com)  
Yamaha Guitar Group, Inc.  
26580 Agoura Road, Calabasas, CA 91302-1921 USA Rev. A



© 2019 Yamaha Guitar Group, Inc. All rights reserved.

Ampeg, the Ampeg logo, and SVT are trademarks or registered trademarks of Yamaha Guitar Group, Inc. in the U.S. and/or other jurisdictions. Speakon is a registered trademark of Neutrik AG Corporation.