

User's Guide for the



SVP-PRO

Bass Preamp



Ampeg® is Proudly Made in America



TABLE OF CONTENTS

Introduction3

Features3

Important Safeguards and Precautions3

The Front Panel4

The Rear Panel5

System Block Diagram5

Important Information About Tubes and Tube Products . . .6

Some Suggested Settings7

Technical Specificationsback cover

	CAUTION RISK OF ELECTRIC SHOCK DO NOT OPEN	
<small>WARNING: TO REDUCE THE RISK OF FIRE OR ELECTRIC SHOCK, DO NOT EXPOSE THIS APPARATUS TO RAIN OR MOISTURE. TO REDUCE THE RISK OF ELECTRIC SHOCK, DO NOT REMOVE COVER. NO USER-SERVICEABLE PARTS INSIDE. REFER SERVICING TO QUALIFIED SERVICE PERSONNEL.</small>		

	PRECAUCION RIESGO DE CORRIENTAZO NO ABRA.	
<small>PRECAUCION: PARA REDUCIR EL RIESGO DE INCENDIOS O DESCARGAS ELECTRICAS, NO PERMITA QUE ESTE APARATO QUEDA EXPUESTO A LA LLUVIA O LA HUMEDAD. PARA DISMINUIR EL RIESGO DE CORRIENTAZO, NO ABRA LA CUBIERTA. NO HAY PIEZAS ADENTRO QUE EL USUARIO PUEDA REPARAR. DEJE TODO MANTENIMIENTO A LOS TECNICOS CALIFICADOS.</small>		

	ATTENTION RISQUE D'ELECTROCUTION NE PAS OUVRIR	
<small>ATTENTION: PROTEGEZ CET APPAREL DE LA PLUIE ET DE L'HUMIDITE AFIN D'EVITER TOUT RISQUE D'INCENDIE OU D'ELECTROCUTION. POUR REDUIRE D'ELECTROCUTION NE PAS ENLEVER LE COUVERCLE. AUCUNE PIECE INTERNE N'EST REPARABLE PAR L'UTILISATEUR. POUR TOUTE REPARATION, S'ADRESSEZ A UN TECHNICIEN QUALIFIE.</small>		

IMPORTANT SAFETY INSTRUCTIONS

- READ, FOLLOW, HEED, AND KEEP ALL INSTRUCTIONS AND WARNINGS.
- DO NOT OPERATE NEAR ANY HEAT SOURCE AND DO NOT BLOCK ANY VENTILATION OPENINGS ON THIS APPARATUS. FOR PROPER OPERATION, THIS UNIT REQUIRES 3" (75CM) OF WELL VENTILATED SPACE AROUND HEATSINKS AND OTHER AIR FLOW PROVISIONS IN THE CABINET.
- DO NOT USE THIS APPARATUS NEAR SPLASHING, FALLING, SPRAYING, OR STANDING LIQUIDS.
- CLEAN ONLY WITH LINT-FREE DAMP CLOTH AND DO NOT USE CLEANING AGENTS.
- ONLY CONNECT POWER CORD TO A POLARIZED, SAFETY GROUNDED OUTLET WIRED TO CURRENT ELECTRICAL CODES AND COMPATIBLE WITH VOLTAGE, POWER, AND FREQUENCY REQUIREMENTS STATED ON THE REAR PANEL OF THE APPARATUS.
- PROTECT THE POWER CORD FROM DAMAGE DUE TO BEING WALKED ON, PINCHED, OR STRAINED.
- UNPLUG THE APPARATUS DURING LIGHTNING STORMS OR WHEN UNUSED FOR LONG PERIODS OF TIME.
- ONLY USE ATTACHMENTS, ACCESSORIES, STANDS, OR BRACKETS SPECIFIED BY THE MANUFACTURER FOR SAFE OPERATION AND TO AVOID INJURY.
- WARNING: TO REDUCE THE RISK OF ELECTRIC SHOCK OR FIRE, DO NOT EXPOSE THIS UNIT TO RAIN OR MOISTURE.
- SERVICE MUST BE PERFORMED BY QUALIFIED PERSONNEL.
- OUR AMPLIFIERS ARE CAPABLE OF PRODUCING HIGH SOUND PRESSURE LEVELS. CONTINUED EXPOSURE TO HIGH SOUND PRESSURE LEVELS CAN CAUSE PERMANENT HEARING IMPAIRMENT OR LOSS. USER CAUTION IS ADVISED AND EAR PROTECTION IS RECOMMENDED IF UNIT IS OPERATED AT HIGH VOLUME.



EXPLANATION OF GRAPHICAL SYMBOLS:
 EXPLICACION DE SIMBOLOS GRAFICOS:
 EXPLICATION DES SYMBOLES GRAPHIQUES:

 = "DANGEROUS VOLTAGE"
 "VOLTAJE PELIGROSO"
 "DANGER HAUTE TENSION"

 = "IT IS NECESSARY FOR THE USER TO REFER TO THE INSTRUCTION MANUAL"
 "ES NECESARIO QUE EL USUARIO SE REFIERA AL MANUAL DE INSTRUCCIONES."
 "REFERREZ-VOUS AU MANUAL D'UTILISATION"

An Introduction to your new Ampeg SVP-PRO Bass Preamp

The harmonically rich sound and legendary performance of the AMPEG SVT are redefined in the SVP-PRO. This dynamic preamp delivers unsurpassed quality, reliability and tonal flexibility, offering the classic vibrancy of tubes as well as contemporary features. The SVP-PRO is the preamp section of our much-respected SVT-2 PRO. All of the features and controls of your SVP-PRO are covered in detail within the pages of this user's guide. We recommend going over them before you use the preamp.

Features

In the world of high performance bass amps, Ampeg's SVT amplifiers stand alone. Keeping with true Ampeg tradition, the SVP-PRO Bass Preamp offers you more performance and flexibility than any other preamp in its class. Listed below are some of the outstanding features of your new preamp - features which set it apart from the competition! Additional information on these features can be found on the pages indicated.

- **PAD:** A switchable attenuator pad, this feature is perfect for basses with active electronics or very "hot" pickups (page 4).
- **MUTE SWITCH:** Lets you cut the sound from the amp, letting you tune your bass in private (page 4).
- **ULTRA LOW, ULTRA HIGH AND BRIGHT SWITCHES:** Lets you tailor your sound in many different ways "with the touch of a button" (page 4).
- **5-POSITION MIDRANGE SELECTOR:** Take your pick from the five center frequency points available to get just the right midrange voice (page 4).
- **9-BAND GRAPHIC EQ:** Use as a "second channel" for bass solos, or to shape your sound to your own exacting standards. An independent level control lets you adjust the Graphic EQ volume. Switchable at front panel or with a footswitch (page 4).
- **TRANSFORMER BALANCED LINE OUT JACK:** For connection to a recording console, PA system or external power amplifier. Switchable for Pre- or Post-EQ operation (page 5).

Important Safeguards and Precautions:

All Ampeg products are designed for continuous safe operation, as long as common sense is used and steps are taken to help avoid certain problems. Abiding by the following rules can help prevent damage to your equipment, yourself, and others.

- The unit is equipped with a three-pronged AC power cord. To reduce the risk of electrical shock, **NEVER** remove or otherwise attempt to defeat the ground pin of the power cord.
- Connect the unit **ONLY** to a properly grounded AC outlet of the proper voltage for your unit.
- Avoid sudden temperature extremes, rain and moisture. Also, avoid sudden and intense impact. (If the unit has been subjected to any of the preceding abuses, have it looked at by an authorized service center.)
- **NEVER** set the unit on a support that might give out under its weight.
- Unplug the unit before cleaning it. **NEVER** spray liquid cleaners onto the unit. Wipe it with a slightly dampened, lint-free cloth to remove dirt and film.
- Do not use the unit if it has sustained damage to the chassis, controls, or power cord. Refer the unit to an authorized service center for inspection.
- Audio equipment capable of producing high volume levels are also capable of inflicting permanent hearing loss or damage, if the exposure to such levels is prolonged. Such damage is progressive and irreversible! Consider using quality hearing protection devices.

The Front Panel:

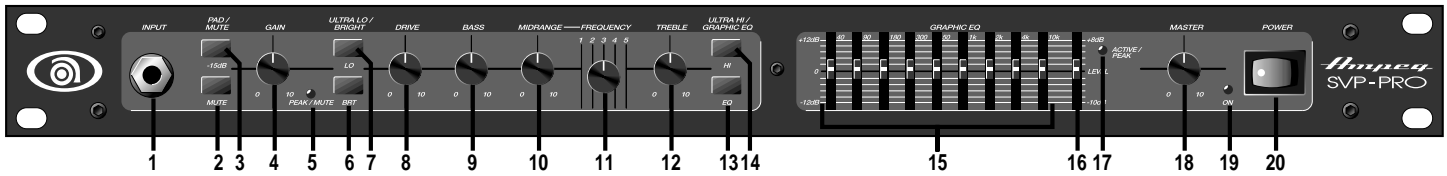

1. INPUT: Use this jack to connect your bass to the preamp by means of a shielded instrument cable.

2. MUTE: This switch, when depressed, mutes the signal at all output jacks except the Tuner Out jack (#27).

3. PAD: This switch, when depressed, attenuates the input signal by 15dB. If your bass has active pickups, depress this switch to better accommodate its output signal.

4. GAIN: Use this control to adjust the level of the input signal. When properly set, the Peak LED (#5) will flash on strong signals. For the best signal to noise ratio set the Gain control to the highest useable setting and adjust the Drive and Master controls (#8, 18) to obtain the desired output level.

5. PEAK/MUTE LED: This LED illuminates when the preamp signal approaches clipping. When the Mute switch (#2) is engaged, this LED stays on as a visual indicator that the Mute function is active.

6. BRIGHT: This switch, when depressed, boosts the upper mid and high frequencies.

7. ULTRA LO: This switch, when depressed, provides emphasis to the low end by boosting the low frequencies and cutting the mid frequencies.

8. DRIVE: Use this control to adjust the level of the distortion. In the fully counter-clockwise position the preamp is in the cleanest, traditional SVT condition. As the control is rotated clockwise, the distortion level is increased. The tone of the signal is also changed to provide a smoother overdrive. The tone controls may have to be readjusted to obtain the desired tone. The Gain control (#4) and Pad (#3) interact with the Drive control. For greater overdrive, the Pad switch (#3) should be out and the Drive control should be rotated fully clockwise. Use the Gain control (#4) to set the amount of overdrive desired. The Peak LED (#5) will remain illuminated when the amplifier is used in this manner.

9. BASS: Use this control to adjust the low frequency output level. This control provides 12dB of cut or boost at 40Hz.

10. MIDRANGE: Use this control to adjust the mid frequency output level. This control provides 15dB of cut or 12dB of boost at the frequency selected by the Frequency control (#11).

11. FREQUENCY: Use this control to select the center frequency for the Midrange control (#10). The center frequencies are 220Hz, 450Hz, 800Hz, 1.6kHz, and 3kHz.

12. TREBLE: Use this control to adjust the high frequency output level. This control provides 12dB of cut or boost at 4kHz.

13. GRAPHIC EQ: This switch, when depressed, activates the Graphic EQ. (When using a footswitch, #23, to control the Graphic EQ, this switch must be depressed.)

14. ULTRA HI: This switch, when depressed, boosts the frequencies above those affected by the Bright switch (#6).

15. GRAPHIC EQ : Use these controls to adjust the amplitude of the signal at the frequency stated above each slider.

16. GRAPHIC EQ LEVEL: Use this control to adjust the overall output level of the Graphic EQ.

17. GRAPHIC EQ ACTIVE/PEAK LED: This LED illuminates yellow when the EQ section is active. This LED will flash when the amplitude of the Graphic EQ signal approaches clipping.

18. MASTER: Use this control to adjust the overall output signal level.

19. POWER INDICATOR LED: This LED illuminates green when the preamp is on.

20. POWER: Use this switch to turn the preamp on (side of switch with the dot depressed) and off (side of switch without the dot depressed).

The Rear Panel

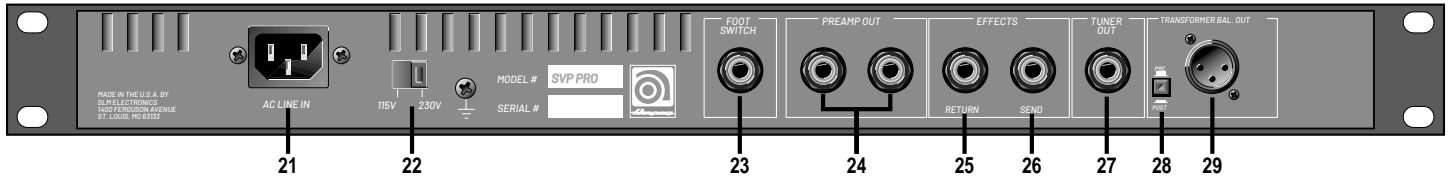

21. AC LINE IN: Firmly insert the female end of the AC power cord into this socket. The grounded power cord should only be plugged into a grounded power outlet that meets all applicable electrical codes and is compatible with the voltage, power and frequency requirements stated on the rear panel. **Do not attempt to defeat the safety ground connection.**

22. AC LINE SELECTOR: Use this switch to match the unit to the AC line voltage.

23. FOOTSWITCH: Use this jack to connect a two-button footswitch to the preamp for remote control of the Mute and Graphic EQ. (Tip controls Mute, ring controls the Graphic EQ.) The front panel switches remain active when a footswitch is connected. *The front panel Graphic EQ switch (#13) must be depressed for the footswitch to control the Graphic EQ.*

24. PREAMP OUTS: Use these jacks to connect the signal from the preamp to your power amplifier, mixing console or house PA system.

25. EFFECTS LOOP RETURN: Use this jack to connect the signal from an external effects processor to the preamp by means of a shielded signal cable.

26. EFFECTS LOOP SEND: Use this jack to connect the signal from the preamp to the input of an external effects processor by means of a shielded signal cable.

27. TUNER OUT: Use this jack to connect the preamp to an external tuner. The signal at this jack is a direct output from the instrument. This is the only signal which remains active when the Mute switch (#2) is depressed.

28. PRE/POST: Use this switch to determine whether the signal at the Transformer Balanced Out jack (#29) is pre-EQ (switch in the out position) or post-EQ (switch depressed).

29. TRANSFORMER BALANCED OUT: Use this XLR jack to connect the preamp to an external power amplifier, mixing console or house PA system. The signal at this jack is pre- or post-EQ depending on the setting of the Pre/Post switch (#28).

System Block Diagram

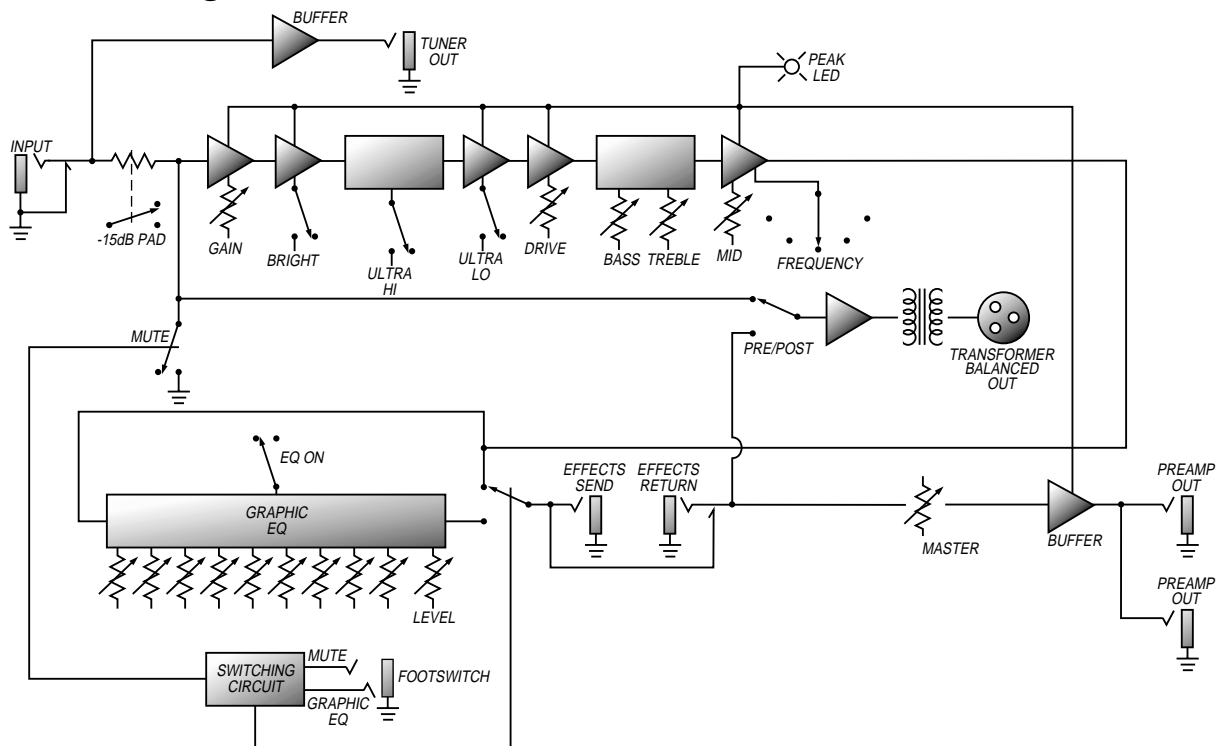



Important Information About Tubes and Tube Products

A BRIEF HISTORY OF THE TUBE:

In 1883, Edison discovered that electrons would flow from a suspended filament when enclosed in an evacuated lamp. Years later, in 1905, Fleming expanded on Edison's discovery and created the "Fleming Valve". Then, in 1907, Dr. Lee de Forest added a third component – the grid – to the "Fleming's Valve" and the vacuum tube was a fact of life. The door to electronic amplification was now open.

During World War II, data gleaned from their intensive research on the detectors used in radar systems led Bell Telephone Laboratories to the invention of the transistor. This reliable little device gained quick support as the new component for amplification. The death of the vacuum tube seemed imminent as designers, scientists, and engineers reveled in the idea of replacing large, fragile glass tubes with these small, solid-state devices.

However, there were (and still are) many serious listeners who realized that the sound produced by a "transistor" amplifier is significantly different from that produced by a tube amplifier with identical design specifications. They considered the sound produced by these new solid-state devices to be hard, brittle, and lifeless. It was determined that solid-state devices produced a less musical set of harmonics than tubes. When pushed past their limits, they tend to mute the tone and emphasize the distortion.

Tubes, on the other hand, produce a more musical set of harmonics, the intensity of which can be controlled by the player. This characteristic adds warmth and definition to the sound which has become the hallmark of tube amplifiers. When tubes are driven into clipping, the harmonic overtones can be both sweet and pleasing or intense and penetrating, depending on the musician's musical taste and playing technique.

Over the years, application engineers have designed a number of outstanding solid-state amplifiers that sound very, very good. Some use special circuitry which enables them to simulate the distortion characteristics of a tube amplifier. However, the tube amplifier, still held in the highest esteem by many musicians, offers a classic "vintage" sound in a contemporary market.

PREAMPLIFIER TUBE TYPES AND USAGE:

The tubes used in preamplifiers (12AX7, 12AU7, 12AT7, etc.) amplify the signal from your instrument and shape the sound. They are inherently microphonic (mechanically pick up and transmit external noises). Since these tubes are used in the critical first stages of a tube preamplifier's circuitry, it is very important to use high-quality, low noise/low microphonic tubes for this application. Although tubes of this quality may be difficult to find and typically cost more than "off-the-shelf" tubes, the improvement in performance is worth the investment.

THE NATURE OF TUBES: WHY (AND WHEN) TO REPLACE THEM:

Tubes are made up of a number of fragile mechanical components that are vacuum-sealed in a glass envelope or bubble. The tube's longevity is based on a number of factors which include how hard and often the equipment is played, vibration from the speakers, road travel, repeated set up and tear down, etc.

If your preamplifier squeals, makes noise, loses gain, starts to hum, lacks "sensitivity", or feels as if it is working against you, the preamplifier tubes may need to be replaced. Remember to use only high quality, low microphonic tubes.

If you're on the road a lot, we recommend that you carry a set of replacement tubes.

SURVIVAL TIPS FOR TUBE PREAMPS:

To prolong tube life, observe these tips and recommendations:

- After using the preamplifier, allow sufficient time for it to properly cool down prior to moving it. A properly cooled preamplifier prolongs tube life due to the internal components being less susceptible to the damage caused by vibration.
- Allow the preamplifier to warm up to room temperature before turning it on. The heat generated by the tube elements can crack a cold glass housing.
- Protect the preamplifier from dust and moisture. If liquid gets into the preamplifier proper, or if the preamplifier is dropped or otherwise mechanically abused, have it checked out at an authorized service center before using it.
- Proper maintenance and cleaning in combination with routine checkups by your authorized service center will insure the best performance and longest life from your preamplifier.

CAUTION: Tube replacement should be performed only by qualified service personnel who are familiar with the dangers of hazardous voltages that are typically present in tube circuitry.



Some Suggested Settings*

JAZZ:

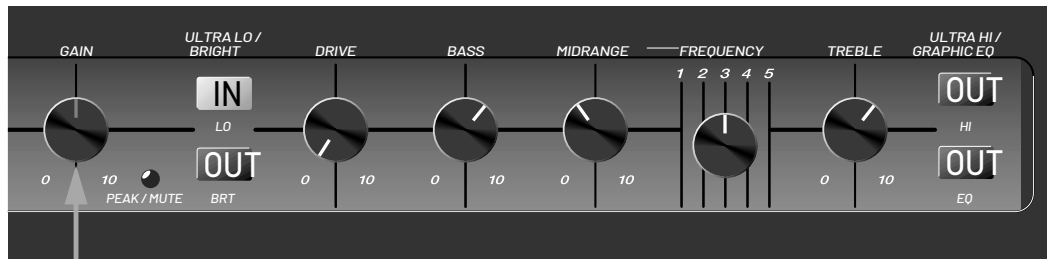

ADJUST UNTIL PEAK LED FLASHES

FUNK:

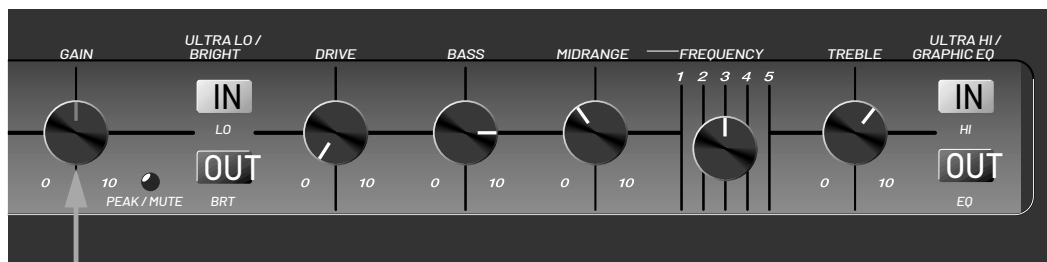

ADJUST UNTIL PEAK LED FLASHES

ROCK:

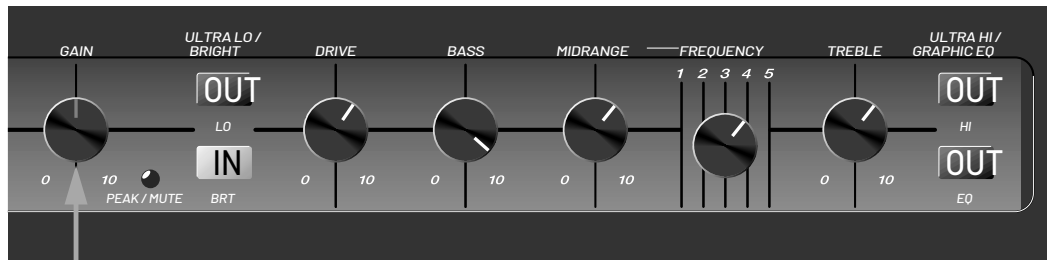

ADJUST UNTIL PEAK LED FLASHES

COUNTRY:

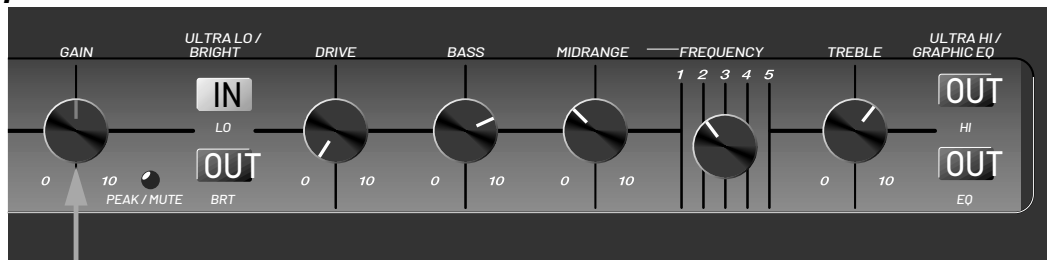

ADJUST UNTIL PEAK LED FLASHES

*A Note About The Graphic EQ:

The Graphic EQ can be used in two ways:

- 1) To fine tune your sound, make small adjustments at the desired frequencies and leave the EQ on throughout the entire session. (This is great for adapting to varying room acoustics when going from club to club, etc.);
- 2) For a completely different sound, make larger adjustments and only activate the EQ when you want a "second channel" sound (such as during bass solos).



SVP-PRO Bass Preamp

Technical Specifications

TOTAL SYSTEM GAIN	76dB, @1kHz w/levels up, tones flat; -3dB @30Hz, 15kHz
TONE CONTROL RANGE	
Bass:	±12dB @ 40Hz
Midrange:	+12dB, -15dB @ Frequency selected (220, 450, 800, 1.6k or 3kHz)
Treble:	±12dB @ 4kHz
Ultra Low:	+3dB @ 40Hz, -12dB @ 500Hz
Ultra High:	+8dB @ 8kHz
Bright:	+7dB @ 2kHz
GRAPHIC EQ RANGE	±12dB @ 40Hz, 90Hz, 180Hz, 300Hz, 500Hz, 1kHz, 2kHz, 4kHz, 10kHz
GRAPHIC EQ LEVEL	+8dB, -10dB
SIGNAL TO NOISE RATIO	80dB typical
TUBE COMPLEMENT	12AX7 (4), 12AU7 (1)
POWER REQUIREMENTS	
Domestic:	120VAC, 60Hz, 28VA
Export:	100/115VAC 50/60Hz, 28VA 230VAC, 50/60Hz, 28VA
SIZE AND WEIGHT	19"W x 1.75"H x 10"D; 9 lbs

Ampeg reserves the right to change specifications without notice.

Declaration Of Conformity

#36, Effective 01-01-2001

Manufacturer's Name: SLM Electronics
Production Facility: 11880 Borman Drive, St. Louis, MO 63146, USA
Production Facility: 700 Hwy 202 W, Yellville, AR 72687, USA
Shipping Facility: 1400 Ferguson Ave., St. Louis, MO 63133, USA
Office Facility: 1400 Ferguson Ave., St. Louis, MO 63133, USA

Product Type: Audio Amplifier

Complies with the following Standards:
Safety: EN60065, E60065, C22.2, UL6500 and/or UL813
EMC: Directive 89/336/EEC, EN55103, EN55013, EN61000, and/or FCC 47CFR 15B c/a

Supplementary information provided by:
 SLM Electronics - R & D Engineering
 1901 Congressional Drive, St Louis, MO 63146, USA
 Tel.: 314-569-0141, Fax: 314-569-0175



www.ameg.com

Ampeg is proudly Made in America

©1999 SLM Electronics

1400 Ferguson Avenue

St. Louis, MO 63133 U.S.A.

P/N 47-546-13 • 032603

