

**OWNERS GUIDE**  
for the  
**SVP-BSP**  
Bass Preamp

Designed for  
Billy Sheehan by





## TABLE OF CONTENTS

- Important Safeguards and Precautions .....2
- Introduction .....3
- Features .....3
- The Front Panel Controls and Their Use .....4
- The Rear Panel .....5
- Some Suggested Settings .....6
- Changing the Tubes .....7
- System Block Diagram .....7
- Technical Specifications .....back cover

### Important Safeguards and Precautions:

All Ampeg products are designed for continuous safe operation, as long as common sense is used and steps are taken to help avoid certain problems. Abiding by the following rules can help prevent damage to your preamp, yourself and others.

- The preamp is equipped with a three-pronged AC power cord. To reduce the risk of electrical shock, **NEVER** remove or otherwise attempt to defeat the ground pin of the power cord.
- Connect the preamp **ONLY** to a properly grounded AC outlet of the proper voltage for your preamp.
- Avoid sudden temperature extremes, rain and moisture. Also, avoid sudden and intense impact. (If the preamp has been subjected to any of the preceding abuses, have it looked at by an authorized service center.)
- Unplug the preamp before cleaning it. **NEVER** spray liquid cleaners onto the preamp. Wipe it with a slightly dampened, lint-free cloth to remove dirt and film.
- Don't use the preamp if it has sustained damage to the chassis, controls, or power cord. Refer the unit to an authorized service center for inspection.
- When using tall or stacked speaker cabinets, use them **ONLY** on a level surface. **NEVER** set tall or stacked cabinets on a surface with more than a five degree incline since tipping or falling could occur, possibly causing serious injuries.
- **NOTE:** Amplifiers capable of producing high volume levels are also capable of inflicting permanent hearing loss or damage, if the exposure to such levels is prolonged. Such damage is progressive and irreversible! **Caution is advised and ear protection is recommended when playing at extremely loud levels.**

The chart below shows the U.S. Government Occupational Safety and Health Administration (OSHA) regulations which were in effect at the time of this publication for permissible noise exposure, per 29CFR1910, Table G-16.

SOUND LEVEL dBA SLOW RESPONSE	DURATION PER DAY IN HOURS	SOUND LEVEL dBA SLOW RESPONSE	DURATION PER DAY IN HOURS
90	8	102	1-1/2
92	6	105	1
95	4	110	1/2
97	3	115	1/4 or less
100	2		

According to OSHA, any exposure in excess of those listed above could result in some hearing loss.

**CAUTION**  
RISK OF ELECTRIC SHOCK  
DO NOT OPEN

**ATTENTION**  
RISQUE D'ELECTROCUTION  
NE PAS OUVRIR

**VORSICHT**  
ELEKTRISCHE SCHLAGEGFAHR  
NICHT OFFENEN

CAUTION: TO REDUCE THE RISK OF ELECTRIC SHOCK, DO NOT REMOVE COVER. NO USER-SERVICEABLE PARTS INSIDE. REFER SERVICING TO QUALIFIED SERVICE PERSONNEL.  
 ATTENTION: POUR REDUIRE D'ELECTROCUTION NE PAS ENLEVER LE COUVERCLE. AUCUNE PIEGE INTERNE N'EST REPARABLE PAR L'UTILISATEUR. POUR TOUTE REPARATION, S'ADRESSER A UN TECHNICIEN QUALIFIE.  
 VORSICHT: ZUR MINIMIERUNG ELEKTRISCHER SCHLAGEGFAHR NICHT DEN DECKEL ABENHMEN. INTERNE TEILE KONNEN NICHT VOM BENUTZER GEWARTET WERDEN. DIE WARTUNG IS QUALIFIZIERTEM WARTUNGSPERSONAL ZU UBERLASSEN.

THIS EQUIPMENT HAS BEEN DESIGNED AND ENGINEERED TO PROVIDE SAFE AND RELIABLE OPERATION. IN ORDER TO PROLONG THE LIFE OF THE UNIT AND PREVENT ACCIDENTAL DAMAGES OR INJURY, PLEASE FOLLOW THESE PRECAUTIONARY GUIDELINES:  
**WARNING:** TO REDUCE THE RISK OF ELECTRIC SHOCK, DO NOT OPEN CHASSIS; DO NOT DEFEAT OR REMOVE THE GROUND PIN OF THE POWER CORD; CONNECT ONLY TO A PROPERLY GROUNDED AC POWER OUTLET.  
**CAUTION:** TO REDUCE THE RISK OF FIRE OR ELECTRIC SHOCK, DO NOT EXPOSE THIS EQUIPMENT TO RAIN OR MOISTURE.  
**CAUTION:** NO USER-SERVICEABLE PARTS INSIDE. REFER SERVICING TO QUALIFIED SERVICE PERSONNEL.  
**CAUTION:** OUR AMPLIFIERS ARE CAPABLE OF PRODUCING HIGH SOUND PRESSURE LEVELS. CONTINUED EXPOSURE TO HIGH SOUND PRESSURE LEVELS CAN CAUSE PERMANENT HEARING IMPAIRMENT OR LOSS. USER CAUTION IS ADVISED AND EAR PROTECTION IS RECOMMENDED IF UNIT IS OPERATED AT HIGH VOLUME.

EXPLANATION OF GRAPHICAL SYMBOLS:

 = "DANGEROUS VOLTAGE"  
 "DANGER HAUTE TENSION"  
 "GEFAHRLICHE SPANNUNG"

= "IT IS NECESSARY FOR THE USER TO REFER TO THE INSTRUCTION MANUAL"  
 "REFERREZ-VOUS AU MANUAL D'UTILISATION"  
 "UNBEDINGT IN DER BEDIENUNGSANLEITUNG NACHSCHLAGEN"



### ***An Introduction to your new Ampeg SVP-BSP Bass Preamp***

When a living legend asks you to design a bass preamp, you don't cut corners – you deliver. So when bassist extraordinaire Billy Sheehan turned to Ampeg for his preamp, we listened to his needs, found out his wants, and made real his dreams: behold, the SVP-BSP bass preamp! A unique piece of gear for the discriminating bassist, with two separate channels – clean and overdrive – and the ability to combine the two channels into a third, at the touch of a button. We even gave each channel its own effects loop and level-controllable balanced XLR output jack.

In designing the SVP-BSP, we were careful not to lose the harmonically rich sound of Ampeg's SVT bass amps. This dynamic preamp still delivers unsurpassed quality, reliability and tonal flexibility, and offers the classic vibrancy of tubes as well as many new features.

All of the features and controls of your SVP-BSP are covered in detail within the pages of this owner's guide. We recommend going over them before you use the preamp.

And a hearty "thank you" from Ampeg – and Billy!

### ***Features***

In the world of high performance bass amps, Ampeg's SVT amplifiers stand alone. Keeping with true Ampeg tradition, the SVP-BSP Bass Preamp offers you more performance and flexibility than any other preamp in its class. Listed below are some of the outstanding features of your new preamp - features which set it apart from the competition! Additional information on these features can be found on the pages indicated.

- **PAD:** Perfect for basses with active electronics or very "hot" pickups (page 4)
- **MUTE SWITCH:** Cuts the sound from the preamp, letting you tune your bass in private (page 4)
- **TWO SEPARATE CHANNELS:** Choose between the clean channel, the overdrive channel, or both, for a wide variety of sounds (page 4, page 6)
- **COMPRESSOR SWITCH:** Evens out your volume by governing the dynamic range of the preamp (page 4)
- **ULTRA LOW, ULTRA HIGH AND GAIN BOOST SWITCHES:** For additional tonal flexibility – lets you further tweak your sound (page 4, page 6)
- **VARIABLE MIDRANGE SELECTOR:** Custom select your center frequency point to get just the right midrange voice (page 4, page 6)
- **GATE SWITCH:** Keeps things quiet in between bass riffs (page 4)
- **FOOTSWITCH CONTROL:** Use a two-button footswitch (like Ampeg's AFP-2) to control channel selection and muting (page 5)
- **TWO EFFECTS LOOPS:** Lets you add your effects to either channel (page 5)
- **TWO PREAMP OUTPUTS:** Each channel has its own 1/4" jack to send its signal to separate amps/speakers if desired (page 5)
- **TWO TRANSFORMER-BALANCED XLR OUTPUTS:** Each channel has its own XLR jack (with level control) to send a balanced signal from the preamp (page 5)



## The Front Panel Controls and Their Use

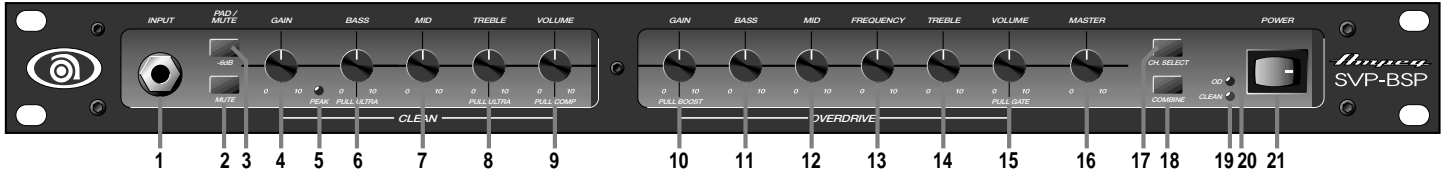

**1. INPUT:** If we have to tell you what to do here, we're both in trouble! (Just remember to use a shielded cable, okay?)

**2. MUTE:** Push this button and the pre-amp's output is cut off (no signal gets through to your amp). The Tuner Out jack (#35) isn't affected by this switch, so you can tune in private. If a footswitch is connected (#23), this switch still remains active.

**3. PAD:** If your bass has active electronics or "hot" pickups (lots of Peak LED with a low Gain setting – see #4 and 5), you'll need this switch. Pressing the switch in reduces the signal level going into the pre-amp by 6dB, allowing you more room to adjust the Gain controls (#4, 10).

### CLEAN CHANNEL:

**4. GAIN:** This control, along with the Pad switch (#3), adjusts the level of the signal going into the clean channel. For the best signal to noise ratio, set this control so that the Peak LED (#5) flashes during your loudest passages.

**5. PEAK LED:** This LED flashes when the signal level into the preamp nears clipping. When the Mute switch (#2) is engaged, this LED stays lit.

**6. BASS:** The low frequency control for the clean channel, with a 20dB range at 40Hz. Pull the knob out to add a boost to the lowest frequencies.

**7. MID:** The midrange control for the clean channel, with a 21dB range at 300Hz.

**8. TREBLE:** The high frequency control for the clean channel, with an 18dB range at 10kHz. Pull the knob out to boost the highest frequencies.

**9. VOLUME:** This controls the output level for the clean channel.

### OVERDRIVE CHANNEL:

**10. GAIN:** This control, along with the Pad switch (#3), adjusts the level of the signal going into the overdrive channel. Pull the knob out to boost the gain (allowing more distortion). With the boost on, the preamp automatically adjusts the frequency response to compensate for the added gain.

**11. BASS:** The low frequency control for the overdrive channel, with 12dB of cut or boost at 100Hz.

**12. MID:** The midrange control for the overdrive channel, with 5dB of cut or 20dB of boost at the center frequency as chosen by the Frequency control (#13).

**13. FREQUENCY:** Allows you to select the center frequency for the Midrange control (#12), giving you a wide range of choices for the "voice" of the Midrange. The center frequencies range from 300Hz at the "0" position to 2kHz at the "10" position.

**14. TREBLE:** The high frequency control for the overdrive channel, with 12dB cut or boost at 7kHz.

**15. VOLUME:** This controls the output level for the overdrive channel. Pull the

knob out to engage the gate circuit – this activates a fixed-threshold noise gate, which virtually turns the channel off when there's no input signal. (This keeps things quiet when your rig is on but you're not actually playing.)

**16. MASTER:** This controls the overall output volume level of the preamp, keeping the same balance between channels as set by their volume controls.

**17. CHANNEL SELECT:** This switch selects the clean channel when out and the overdrive channel when in. When a footswitch (#23) is used, this switch is disabled.

**18. COMBINE:** This switch does exactly what it says: it combines the clean channel with the overdrive channel when the overdrive channel is selected.

**NOTE:** In order to hear a combination of the two channels, the Channel Select switch (#17) must be in the OVERDRIVE ("in") position. Otherwise, only the clean channel will be heard.

**19. CLEAN LED:** This LED indicator glows green when the Clean channel is active.

**20. OVERDRIVE LED:** This LED indicator glows red when the Overdrive channel is active.

**21. POWER:** This switch turns the pre-amp on (towards the white mark) and off.



## The Rear Panel

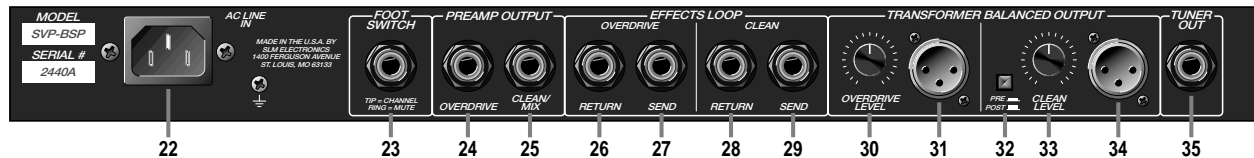

**22. AC LINE IN:** Connect the power cord here, making sure it is fully seated in the socket. Plug the male end of the cord into a grounded AC outlet. **DO NOT DEFEAT THE GROUND PRONG OF THE AC PLUG!**

**23. FOOTSWITCH:** Connect a two-button footswitch here for control of muting and channel selection: tip = channel select, ring = mute, sleeve = ground.

**NOTE:** With a footswitch attached, the channel select footswitch overrides the front panel channel switch; however, the front panel mute switch remains active.

**24, 25. PREAMP OUTPUTS:** Connect these jacks to your power amp(s). If only the Clean/Mix output (#25) is used, all outputs (clean, overdrive, and combined) appear at this jack. When a plug is insert-

ed into the Overdrive output (#24), the clean and overdrive outputs appear at their respective jacks.

**26 – 29. EFFECTS LOOPS:** Each channel of the preamp has its own effects loop for connecting external effects. Connect the Send jack (#27 or 29, depending on the channel) to the input of the device, then connect the output of the device to the Return jack (#26 or 28).

**30, 33. BALANCED OUTPUT LEVELS:** These controls adjust the levels of the signals at the Balanced Output jacks: #30 is for Overdrive, #33 is for Clean.

**31, 34. BALANCED OUTPUT JACKS:** These XLR-type jacks can be used to feed an external power amplifier, mixing console, or house PA system: #31 is for Overdrive, #34 is for Clean. The overdrive

output is post volume and pre master. The clean channel's output is selected via the pre/post switch (#32).

**32. PRE/POST:** In the post position (switch out), the signal is post volume, pre master. In the pre position (switch in), the signal is taken directly from the preamp tube. It's like having a built-in tube direct box in the preamp.

**35. TUNER OUT:** This jack lets you send a direct signal from your bass to your tuner, regardless of the settings of the preamp. Even with the Mute on, the output at this jack is the same as if you connected directly from your bass.



### Some Suggested Settings

**Smooth**

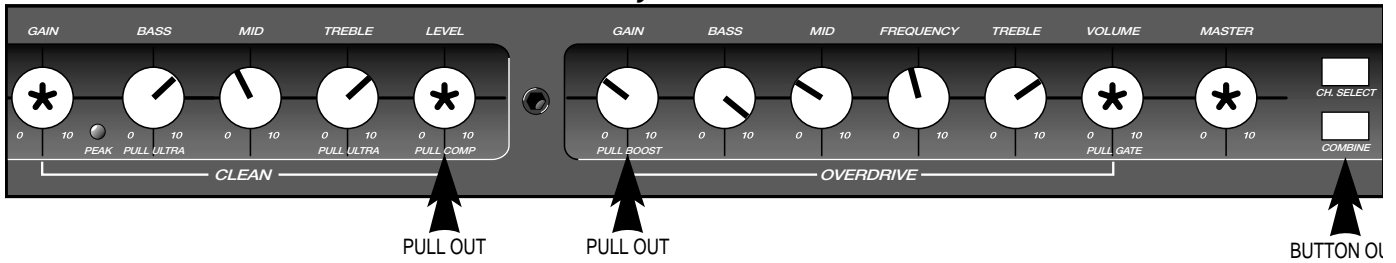

**Dirty SVT**

**Slappin'**

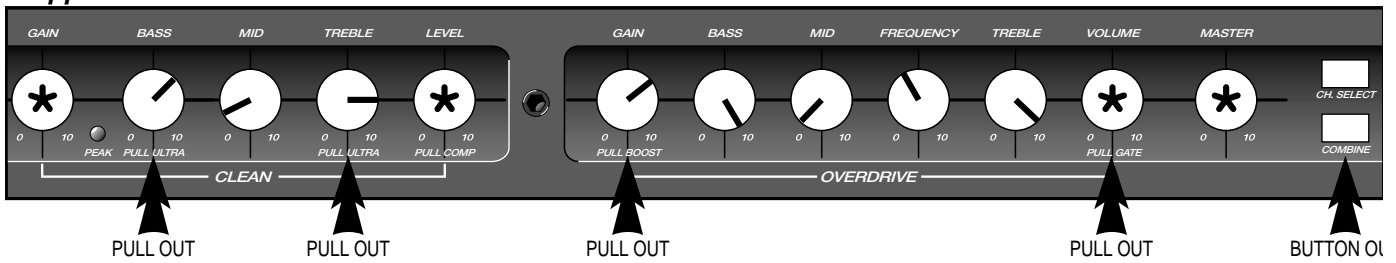

**Metal**



**Mud & Fuzz**

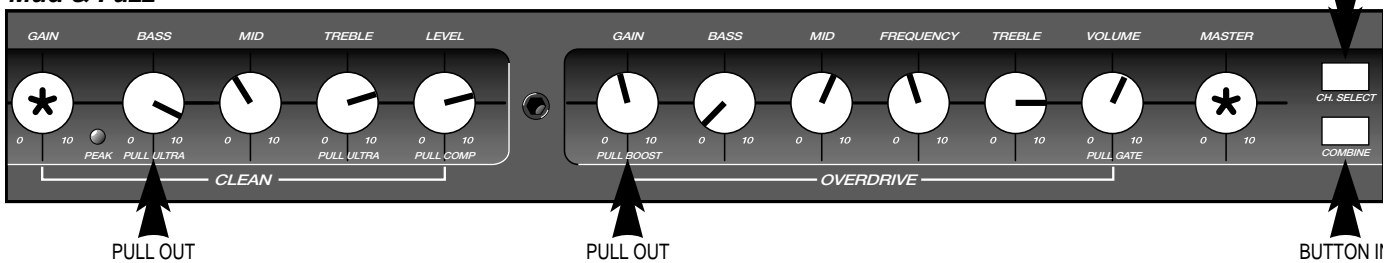

**"Big" Bass**

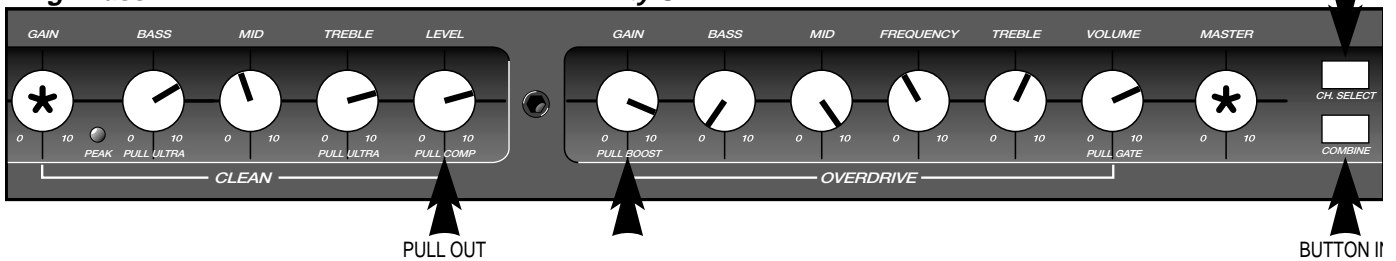



## Changing the Tube

Tube wear is in direct proportion to how often you use the preamp. When the tube wears out, the preamp may squeal, get noisy, lose gain and sensitivity, or just quit working. To get to the tube in the SVP-BSP, the top must be removed. **This should be left to a qualified service person.**

## System Block Diagram

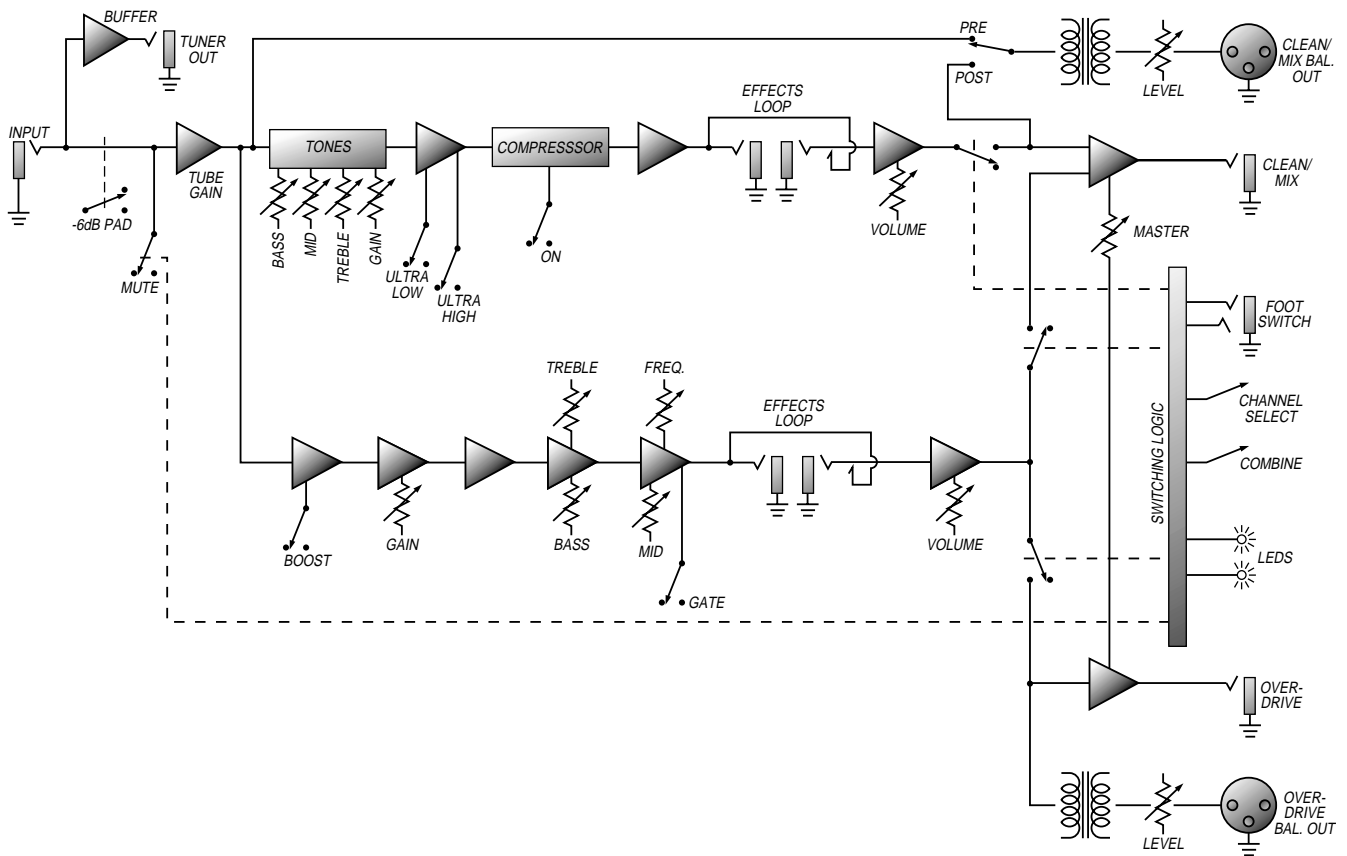



## SVP-BSP Bass Preamp

### Technical Specifications

#### TOTAL SYSTEM GAIN

Clean Channel	22dB, @1kHz w/levels up, tones flat
Overdrive Channel	80dB, @1kHz w/levels up, tones flat

---

#### TONE CONTROL RANGE

##### Clean Channel

Bass:	20dB range @ 40Hz
Midrange:	21dB range @ 300Hz
Treble:	18dB range @ 10kHz
Ultra Low:	+5dB @ 30Hz
Ultra High:	+7dB @ 15kHz

##### Overdrive Channel

Bass:	±12dB @ 100Hz
Midrange:	+20dB, -5dB @ 300 – 2kHz
Treble:	±12dB @ 7kHz

---

**SIGNAL TO NOISE RATIO** 80dB typical, Clean channel

---

**TUBE COMPLEMENT** 12AX7 (1)

---

#### POWER REQUIREMENTS

Domestic:	120VAC, 60Hz, 15VA
Export:	100/120VAC 50/60Hz, 15VA 220 – 240VAC, 50/60Hz, 15VA

---

**SIZE AND WEIGHT** 19"W x 1.75"H x 10"D; 10 lbs

---

*Ampeg reserves the right to change specifications without notice.*



[www.ameg.com](http://www.ameg.com)

Ampeg is proudly Made in America

©1999 SLM Electronics

1400 Ferguson Avenue

St. Louis, MO 63133 U.S.A.

P/N 47-546-51 • 01-99

